

Test Report

(EN 50155 & EN 50121-3-2)

Report No.: CEBDBO-WTW-P21030356-1

Test Model: SPC-7000

Series Model: SPC-7000 Series, SPC-7XXXXXXXXXXXXXXXXXXXXXXXXXXXXX
("X" can be 0-9, A-Z or blank for marketing purposes)

Received Date: Mar. 10, 2021

Test Date: Mar. 24 to Jul. 7, 2021

Issued Date: Aug. 5, 2021

Applicant: Vecow Co., Ltd.

Address: 3F., No.10, Jiankang Rd., Zhonghe Dist., New Taipei City 23586, Taiwan

Issued By: Bureau Veritas Consumer Products Services (H.K.) Ltd., Taoyuan Branch
Lin Kou Laboratories

Lab Address: No. 47-2, 14th Ling, Chia Pau Vil., Lin Kou Dist., New Taipei City, Taiwan



This report is for your exclusive use. Any copying or replication of this report to or for any other person or entity, or use of our name or trademark, is permitted only with our prior written permission. This report sets forth our findings solely with respect to the test samples identified herein. The results set forth in this report are not indicative or representative of the quality or characteristics of the lot from which a test sample was taken or any similar or identical product unless specifically and expressly noted. Our report includes all of the tests requested by you and the results thereof based upon the information that you provided to us. You have 60 days from date of issuance of this report to notify us of any material error or omission caused by our negligence, provided, however, that such notice shall be in writing and shall specifically address the issue you wish to raise. A failure to raise such issue within the prescribed time shall constitute your unqualified acceptance of the completeness of this report, the tests conducted and the correctness of the report contents. Unless specifically mentioned, the uncertainty of measurement has been explicitly taken into account to declare the compliance or non-compliance to the specification.

Table of Contents

Release Control Record	4
1 Certificate of Conformity	5
2 Summary of Test Results	6
2.1 Performance Criteria	9
2.2 Measurement Uncertainty	9
2.3 Modification Record.....	9
3 General Information	10
3.1 Description of EUT	10
3.2 Features of EUT	10
3.3 Operating Modes of EUT and Determination of Worst Case Operating Mode	11
3.4 Test Program Used and Operation Descriptions.....	12
3.5 Primary Clock Frequencies of Internal Source	12
4 Configuration and Connections with EUT	13
4.1 Connection Diagram of EUT and Peripheral Devices.....	13
4.2 Configuration of Peripheral Devices and Cable Connections	15
5 Conducted Disturbance at Auxiliary a.c. or d.c. Power Ports	17
5.1 Limits	17
5.2 Test Instruments	17
5.3 Test Arrangement	18
5.4 Test Results	19
6 Radiated Disturbance up to 1 GHz	21
6.1 Limits	21
6.2 Test Instruments	21
6.3 Test Arrangement	22
6.4 Test Results	23
7 Radiated Disturbance above 1 GHz	25
7.1 Limits	25
7.2 Test Instruments	25
7.3 Test Arrangement	26
7.4 Test Results	27
8 Harmonics Current Measurement	29
8.1 Limits	29
8.2 Classification of Equipment.....	29
8.3 Test Instruments	29
8.4 Test Arrangement	30
8.5 Test Results	30
9 Voltage Fluctuations and Flicker Measurement	31
9.1 Limits	31
9.2 Test Instruments	31
9.3 Test Arrangement	31
9.4 Test Results	32
10 Electrostatic Discharge Immunity Test (ESD)	33
10.1 Test Specification.....	33
10.2 Test Instruments	33
10.3 Test Arrangement	33
10.4 Test Results	35

11	Radio-frequency Electromagnetic Field Immunity Test (RS)	38
11.1	Test Specification.....	38
11.2	Test Instruments	38
11.3	Test Arrangement	39
11.4	Test Results	40
12	Electrical Fast Transient/Burst Immunity Test (EFT)	41
12.1	Test Specification.....	41
12.2	Test Instruments	41
12.3	Test Arrangement	42
12.4	Test Results	43
13	Surge Immunity Test	44
13.1	Test Specification.....	44
13.2	Test Instruments	44
13.3	Test Arrangement	45
13.4	Test Results	45
14	Immunity to Conducted Disturbances Induced by RF Fields (CS)	46
14.1	Test Specification.....	46
14.2	Test Instruments	47
14.3	Test Arrangement	49
14.4	Test Results	50
15	Pictures of Test Arrangements	51
15.1	Conducted Disturbance at Auxiliary a.c. or d.c. power ports	51
15.2	Radiated Disturbance up to 1 GHz	52
15.3	Radiated Disturbance above 1 GHz.....	53
15.4	Harmonics Current, Voltage Fluctuations and Flicker Measurement.....	54
15.5	Electrostatic Discharge Immunity Test (ESD)	54
15.6	Radio-frequency Electromagnetic Field Immunity Test (RS)	55
15.7	Fast Transients (EFT).....	56
15.8	Surge	58
15.9	Radio-frequency common mode (CS).....	59
Appendix – Information of the Testing Laboratories		61

Release Control Record

Issue No.	Description	Date Issued
CEBDBO-WTW-P21030356-1	Original release.	Aug. 5, 2021

1 Certificate of Conformity

Product: Ultra-Compact Fanless Embedded Box PC
Brand: Vecow
Test Model: SPC-7000
Series Model: SPC-7000 Series, SPC-7XXXXXXXXXXXXXXXXXXXXXXXXXXXXX
(“X” can be 0-9, A-Z or blank for marketing purposes)
Sample Status: Engineering sample
Applicant: Vecow Co., Ltd.
Test Date: Mar. 24 to Jul. 7, 2021
Standards: **EN 50155:2017, Clause 13.4.8**
EN 61000-3-2:2014
EN 61000-3-3:2013
EN 50121-1:2017
EN 50121-3-2:2016
EN 61000-4-2:2009
EN 61000-4-3:2006 +A1:2008 +A2:2010
EN 61000-4-4:2012
EN 61000-4-5:2014 +A1:2017
EN 61000-4-6:2014 +AC:2015

The above equipment has been tested by **Bureau Veritas Consumer Products Services (H.K.) Ltd., Taoyuan Branch**, and found compliance with the requirement of the above standards. The test record, data evaluation & Equipment Under Test (EUT) configurations represented herein are true and accurate accounts of the measurements of the sample’s EMC characteristics under the conditions specified in this report.

Prepared by :  , **Date:** Aug. 5, 2021
Vivian Chen / Senior Specialist

Approved by :  , **Date:** Aug. 5, 2021
Jim Hsiang / Associate Technical Manager

2 Summary of Test Results

EN 50121-3-2:2016, Emission requirements, EN 50155:2017, Clause 13.4.8			
Port	Test Item / specifications	Result/Remarks	Verdict
Auxiliary a.c. or d.c. power ports - Auxiliary supply sinusoidal a.c. or d.c.	Conducted disturbance 150 kHz- 500 kHz: 99 dB μ V quasi-peak 500 kHz- 30 MHz: 93 dB μ V quasi-peak	Minimum passing margin is -42.77 dB at 0.76790 MHz	Pass
Auxiliary a.c. or d.c. power ports – AC power outlet port for public use	Conducted disturbance 50 Hz- 2 kHz: THD <8% (THD: total harmonic distortion)	Test not applicable because the port does not exist.	N/A
Battery referenced ports - Battery power supply	Conducted disturbance 150 kHz- 500 kHz: 99 dB μ V quasi-peak 500 kHz- 30 MHz: 93 dB μ V quasi-peak	Test not applicable because the port does not exist.	N/A
Enclosure	Radiated disturbance 30 MHz- 230 MHz: 40 dB μ V/m quasi-peak 230 MHz -1 GHz: 47 dB μ V/m quasi-peak	Minimum passing margin is -4.73 dB at 192.86 MHz	Pass
Enclosure	Radiated disturbance 1 GHz- 3 GHz: 76 dB μ V/m peak 56 dB μ V/m average 3 GHz - 6 GHz: 80 dB μ V/m peak 60 dB μ V/m average	Minimum passing margin is -7.49 dB at 5399.94 MHz	Pass

Emission requirements			
Standard	Test Item / specifications	Result/Remarks	Verdict
EN 61000-3-2:2014	Harmonic current emissions	The power consumption of EUT is less than 75W and no limits apply	Pass
EN 61000-3-3:2013	Voltage fluctuations and flicker	$P_{st} \leq 1.0$ $d_{max} \leq 4\%$ $P_{lt} \leq 0.65$ $d_c \leq 3.3\%$ $T_{max} \leq 500ms$	Pass

EN 50121-3-2:2016, Immunity requirements, EN 50155:2017, Clause 13.4.8					
Table Clause	Basic standard	Port	Test Item / specifications	Result/Remarks	Verdict
3.1	EN 61000-4-6:2014 +AC:2015	Battery referenced ports (except at the output of energy sources), Auxiliary a.c. power input ports (rated voltage ≤ 400 Vrms)	Radio-frequency common mode (CS) 80% AM (1kHz) 0.15-80 MHz, 10V Performance Criterion A	Performance Criterion A	Pass
3.2	EN 61000-4-4:2012	Battery referenced ports (except at the output of energy sources), Auxiliary a.c. power input ports (rated voltage ≤ 400 Vrms)	Fast Transients (EFT) 5/50 (t_r/t_w) ns, 5kHz ± 2 kV Performance Criterion A	Performance Criterion A	Pass
3.3	EN 61000-4-5:2014 +A1:2017	Battery referenced ports (except at the output of energy sources), Auxiliary a.c. power input ports (rated voltage ≤ 400 Vrms)	Surges 1.2/50 (8/20) (T_f/T_d) μ s Line to ground: ± 2 kV 42 Ω , 0.5 μ F Line to line: ± 1 kV 42 Ω , 0.5 μ F Performance Criterion B	Performance Criterion A	Pass
4.1	EN 61000-4-6:2014 +AC:2015	Signal & communication, process measurement & control ports	Radio-frequency common mode (CS) 80% AM (1kHz) 0.15-80 MHz, 10V Performance Criterion A	Judge by client	
4.2	EN 61000-4-4:2012	Signal & communication, process measurement & control ports	Fast Transients (EFT) 5/50 (t_r/t_w) ns, 5kHz ± 2 kV, Capacitive clamp Performance Criterion A	Performance Criterion A	Pass
5.1	EN 61000-4-3:2006 +A1:2008 +A2:2010	Enclosure ports	Radio-frequency electromagnetic field amplitude modulated (RS) ¹ , 80% AM (1kHz) 80-800 MHz, 20V/m Performance Criterion A	Performance Criterion A	Pass
5.2	EN 61000-4-3:2006 +A1:2008 +A2:2010	Enclosure ports	Radio-frequency electromagnetic field from digital mobile telephones (RS) ² , 80% AM (1kHz) 800-1000 MHz, 20V/m 1400-2000 MHz, 10V/m 2000-2700 MHz, 5V/m 5100-6000 MHz, 3V/m Performance Criterion A	Performance Criterion A	Pass

EN 50121-3-2:2016, Immunity requirements,
EN 50155:2017, Clause 13.4.8

Table Clause	Basic standard	Port	Test Item / specifications	Result/Remarks	Verdict
5.3	EN 61000-4-2:2009	Enclosure ports	Electrostatic Discharges (ESD) ±6kV Contact discharge ±8kV Air discharge Performance Criterion B	Performance Criterion B	Pass

Note 1: This limit applies to equipment mounted in the passenger compartments, drivers cab or external to the rolling stock (roof, underframe). For equipment mounted in all other areas a severity level of 10 V/m may be used.

Note 2: For large apparatus (e.g. traction drives, auxiliary converters) it is often not practical to perform the immunity test to radiated electromagnetic fields on the complete unit. In such cases the manufacturer should test susceptible sub-systems (e.g. control electronics). The test report should justify the selection or not of sub-systems and any assumptions made (e.g. reduction of field due to case shielding).

Note:

1. There is no deviation to the applied test methods and requirements covered by the scope of this report.
2. The above EN basic standards are applied with latest version if customer has no special requirement.
3. Determining compliance based on the results of the compliance measurement, not taking into account measurement instrumentation uncertainty.
4. N/A: Not Applicable

2.1 Performance Criteria

General Performance Criteria

The general performance criteria apply for those ports for which no specific performance criteria are defined (e.g. auxiliary ports) in the report.

Performance criterion A: The apparatus shall continue to operate as intended during and after the test. No degradation of performance or loss of function is allowed below a performance level specified by the manufacturer, when the apparatus is used as intended. The performance level may be replaced by a permissible loss of performance. If the minimum performance level or the permissible performance loss is not specified by the manufacturer, either of these may be derived from the product description and documentation, and from what the user may reasonably expect from the apparatus if used as intended..

Performance criterion B: The apparatus shall continue to operate as intended after the test. No degradation of performance or loss of function is allowed below a performance level specified by the manufacturer, when the apparatus is used as intended. The performance level may be replaced by a permissible loss of performance. During the test, degradation of performance is however allowed. No change of actual operating state or stored data is allowed. If the minimum performance level or the permissible performance loss is not specified by the manufacturer, either of these may be derived from the product description and documentation, and from what the user may reasonably expect from the apparatus if used as intended.

Performance criterion C: Temporary loss of function is allowed, provided the function is self-recoverable or can be restored by the operation of the controls.

2.2 Measurement Uncertainty

Where relevant, the following measurement uncertainty levels have been estimated for tests performed on the EUT as specified in CISPR 16-4-2:

Measurement	Expanded Uncertainty (k=2) (\pm)	Maximum allowable uncertainty (\pm)
Conducted disturbance at mains port using AMN, 150kHz ~ 30MHz	2.94 dB	3.4 dB (U_{CISPR})
Radiated disturbance, 30MHz ~ 1GHz	4.30 dB	6.3 dB (U_{CISPR})
Radiated disturbance, 1GHz ~ 6GHz	4.48 dB	5.2 dB (U_{CISPR})

The other instruments specified are routine verified to remain within the calibrated levels, no measurement uncertainty is required to be calculated.

2.3 Modification Record

There were no modifications required for compliance.

3 General Information

3.1 Description of EUT

Product	Ultra-Compact Fanless Embedded Box PC
Brand	Vecow
Test Model	SPC-7000
Series Model	SPC-7000 Series, SPC-7XXXXXXXXXXXXXXXXXXXXXXXXXXXXX (“X” can be 0-9, A-Z or blank for marketing purposes)
Model Difference	For marketing purpose
Sample Status	Engineering sample
Operating Software	Windows 10, Burnintest
Power Supply Rating	DC from Adapter
Accessory Device	N/A
Data Cable Supplied	N/A

Note:

The EUT uses following adapter.

Brand	FSP
Model	FSP120-AABN
Input Power	100-240Vac, 1.8A, 50-60Hz
Output Power	24Vdc, 5A, 120W
Power Line	AC 3Pin Non-shielded DC cable (1.5m) with one ferrite core.

3.2 Features of EUT

1. The tests reported herein were performed according to the method specified by Vecow Co., Ltd., for detailed feature description, please refer to the manufacturer's specifications or user's manual.
2. The EUT was configured with the following key components:

Components	Brand	Model	Specification
CPU	Intel	i7-1185G7E	2.8GHz
RAM	innodisk	-	DDR4 2133 16GB
SSD	CERVOZ	-	2.5" SATA 256GB

3.3 Operating Modes of EUT and Determination of Worst Case Operating Mode

1. The EUT is designed with AC power of rating 100-240Vac, 50-60Hz. For radiated emission evaluation, 230Vac/50Hz (for EN 50155), 120Vac/60Hz (for FCC Part 15) had been covered during the pre-test. The worst data was found at **120Vac/60Hz** and recorded in the applied test report.
2. Test modes are presented in the report as below.

Mode	Test Condition	Input Power
Conducted emission test		
1	Full System (Display* 2: 4096*2304, 60Hz)	230Vac/ 50Hz
Radiated emission test		
1	Full System (Display* 2: 4096*2304, 60Hz)	120Vac/ 60Hz
Harmonics & Flicker and Immunity tests		
1	Full System (Display* 2: 4096*2304, 60Hz)	230Vac/ 50Hz

3.4 Test Program Used and Operation Descriptions

Emission tests (Harmonics & Flicker excluded):

- a. Turned on the power of all equipment.
- b. EUT ran a test program to enable all functions.
- c. EUT read and wrote messages from/to SSD, SIM card and ext. HDD.
- d. EUT sent and received messages to/from Notebook PC/ PC (kept in a remote area) via two UTP LAN cables (10m each).
- e. EUT sent "H" messages to ext. LCD Monitors. Then they displayed "H" messages on their screens simultaneously.
- f. EUT sent messages to printer and printer printed them out.
- g. EUT sent 1kHz audio signal to earphone.
- h. Steps c-g were repeated.

Harmonics, Flicker, Immunity tests:

- a. Turned on the power of all equipment.
- b. EUT ran a test program to enable all functions.
- c. EUT read and wrote messages from/to SSD and ext. SSD.
- d. EUT sent and received messages to/from Notebook PC (kept in a remote area) via two UTP/STP LAN cables (10m each).
- e. EUT sent color bars messages to ext. LCD Monitors. Then they displayed color bars messages on their screens simultaneously.
- f. EUT sent audio signal to speaker.
- g. Steps c-f were repeated.

3.5 Primary Clock Frequencies of Internal Source

The highest frequency generated or used within the EUT or on which the EUT operates or tunes is 2.8GHz, provided by Vecow Co., Ltd., for detailed internal source, please refer to the manufacturer's specifications.

4 Configuration and Connections with EUT

4.1 Connection Diagram of EUT and Peripheral Devices

Emission tests (Harmonics & Flicker excluded):

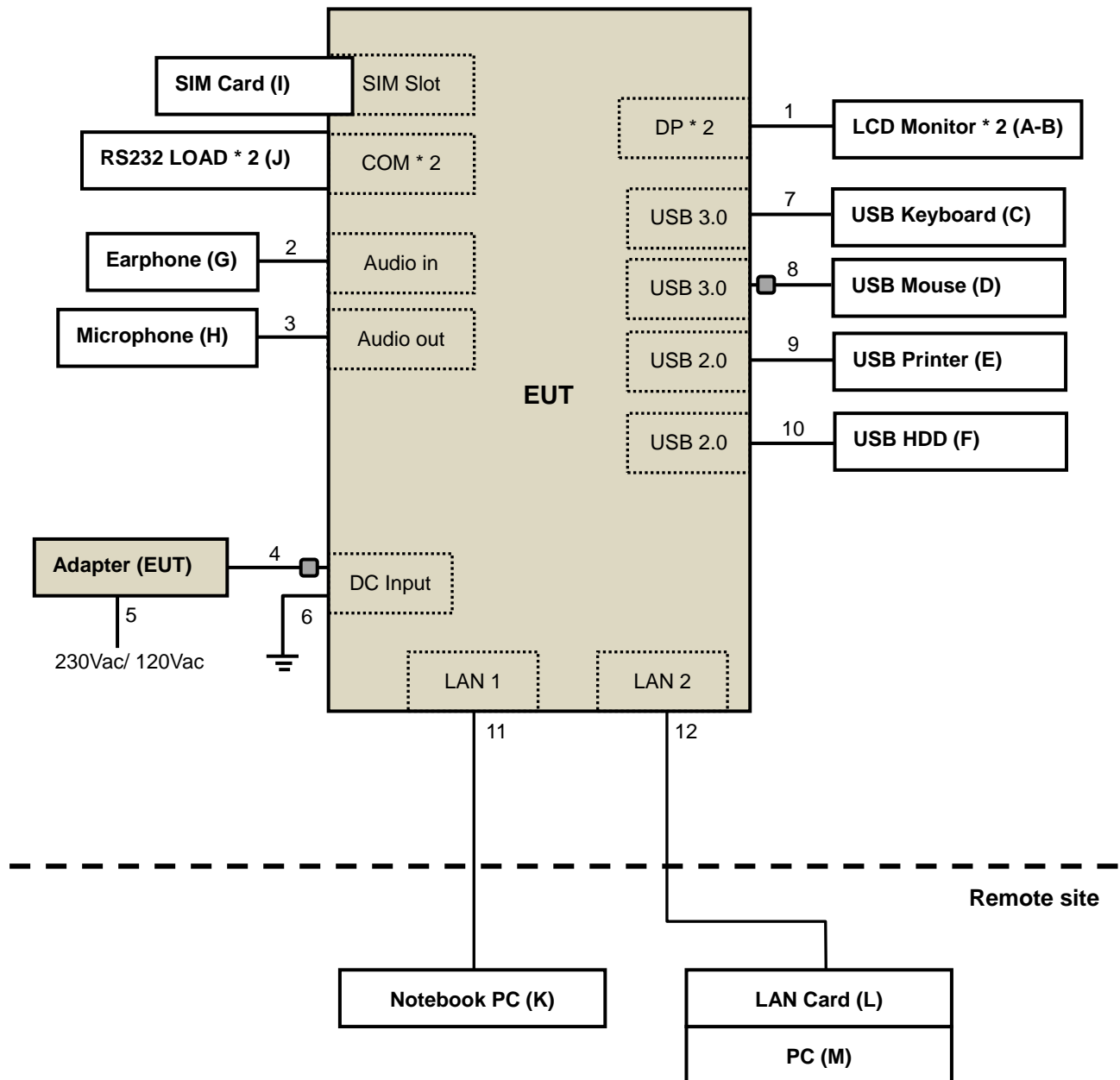

Harmonics & Flicker & Immunity tests:

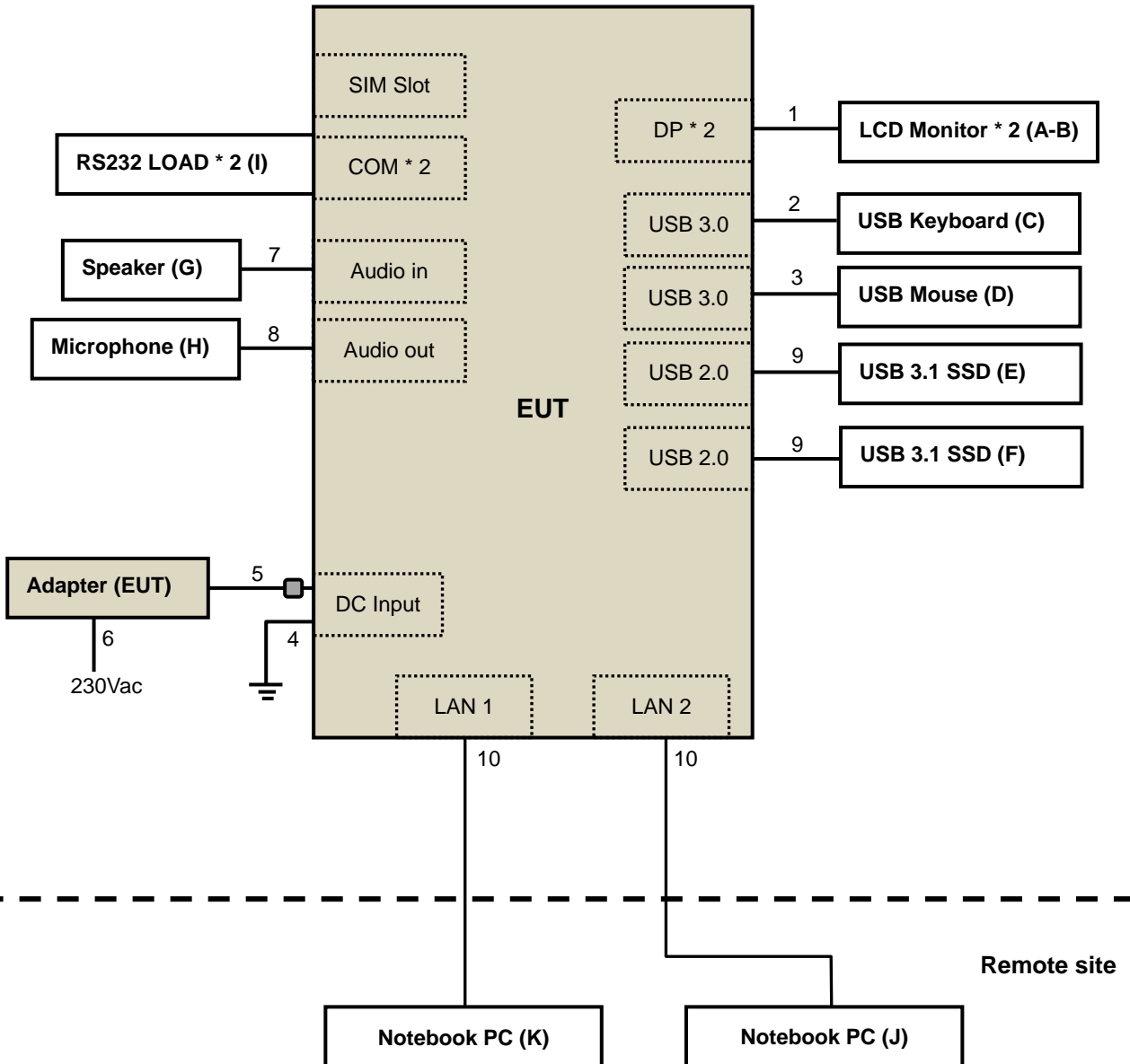

4.2 Configuration of Peripheral Devices and Cable Connections

Emission tests (Harmonics & Flicker excluded):

ID	Product	Brand	Model No.	Serial No.	FCC ID	Remarks
A.	LCD MONITOR	ASUS	MX27U	JBLMRS007843	NA	Provided by Lab
B.	LCD MONITOR	ASUS	MX27U	K1LMRS022990	NA	Provided by Lab
C.	USB Keyboard	Dell	KB216t	CN-0W33XP-LO300-7CL-1909	NA	Provided by Lab
D.	USB Mouse	Microsoft	1113	9170528318308	FCC DoC Approved	Provided by Lab
E.	USB Printer	HP	HP Officejet Pro 251dw	CN55FCV012	FCC DoC Approved	Provided by Lab
F.	USB 3.1 Hard Disk	Transcend	SSD220S	SK21D1718X009P	NA	Supplied by client
G.	EARPHONE	PHILIPS	SBC HL145	N/A	NA	Provided by Lab
H.	MICROPHONE	Labtec	mic-333	N/A	NA	Provided by Lab
I.	SIM Card	NA	NA	NA	NA	Provided by Lab
J.	RS232 Load * 2	NA	NA	NA	NA	Supplied by client
K.	Notebook PC	SONY	SVS151A12P	275548477001024	NA	Provided by Lab
L.	LAN Card	ASUS	XG-C100C	H4QSRT000342	NA	Provided by Lab
M.	PERSONAL COMPUTER	DELL	VOSTRO 470	JWHKYBX	NA	Provided by Lab

Note:

1. All power cords of the above support units are non-shielded (1.8m).
2. Items K-M acted as communication partners to transfer data.

ID	Cable Descriptions	Qty.	Length (m)	Shielding (Yes/No)	Cores (Qty.)	Remarks
1.	DP cable	2	1.8	Y	0	Provided by Lab
2.	Audio cable	1	1.2	N	0	Provided by Lab
3.	Audio cable	1	2.5	N	0	Provided by Lab
4.	DC power cable	1	1.5	N	1	Supplied by client
5.	AC power cable	1	1.8	N	0	Supplied by client
6.	GND cable	1	1.5	N	0	Provided by Lab
7.	USB cable	1	1.8	Y	0	Provided by Lab
8.	USB cable	1	1.8	Y	1	Provided by Lab
9.	USB cable	1	1.8	Y	0	Provided by Lab
10.	USB cable	1	1.0	Y	0	Provided by Lab
11.	LAN cable	1	10	N	0	Provided by Lab (RJ45, Cat.5e)
12.	LAN cable	1	10	N	0	Provided by Lab (RJ45, Cat.5e)

Note: The core(s) is(are) originally attached to the cable(s).

Harmonics, Flicker, Immunity tests:

ID	Product	Brand	Model No.	Serial No.	FCC ID	Remarks
A.	LCD MONITOR	DELL	U2412M	CN-07N2FG-TV100-7 BG-039L	NA	Provided by Lab
B.	LCD MONITOR	DELL	U2412M	CN-07N2FG-TV100-9 75-095U	NA	Provided by Lab
C.	USB Keyboard	hp	KU-1060	NA	NA	Provided by Lab
D.	USB Mouse	Lenovo	MOEUUOA	NA	NA	Provided by Lab
E.	USB 3.1 SSD	WD	WDBK VX5120PS L	1922MD400824	FCC DoC Approved	Provided by Lab
F.	USB 3.1 SSD	WD	WDBK VX5120PS L	1922JG400125	NA	Supplied by client
G.	Speaker	N/A	NA	N/A	NA	Provided by Lab
H.	MICROPHONE	Labtec	mic-333	N/A	NA	Provided by Lab
I.	RS232 Load * 2	NA	NA	NA	NA	Supplied by client
J.	Notebook PC	LENOVO	TP00057A	R9-0JMLFS16/01	NA	Provided by Lab
K.	Notebook PC	Lenovo	T470	PF-0QW0NQ	NA	Provided by Lab

Note:

1. All power cords of the above support units are non-shielded (1.8m).
2. Items J-L acted as communication partners to transfer data.

ID	Cable Descriptions	Qty.	Length (m)	Shielding (Yes/No)	Cores (Qty.)	Remarks
1.	DP cable	2	1.8	Y	0	Provided by Lab
2.	USB cable	1	1.8	Y	0	Provided by Lab
3.	USB cable	1	1.8	Y	0	Provided by Lab
4.	GND cable	1	2.0	N	0	Provided by Lab
5.	DC power cable	1	1.5	N	1	Supplied by client
6.	AC power cable	1	1.8	N	0	Supplied by client
7.	Audio cable	1	1.0	N	0	Provided by Lab
8.	Audio cable	1	1.0	N	0	Provided by Lab
9.	USB cable	2	0.3	Y	0	Provided by Lab
10.	LAN cable	2	10	N	0	Provided by Lab (RJ45, Cat.5e)
	LAN cable (For RS, CS test)	2	10	Y	0	Provided by Lab (RJ45, Cat.5e)

Note: The core(s) is(are) originally attached to the cable(s).

5 Conducted Disturbance at Auxiliary a.c. or d.c. Power Ports

5.1 Limits

Frequency (MHz)	Quasi-peak, (dBuV)
0.15 - 0.5	99
0.5 - 30	93

Notes: 1. The lower limit shall apply at the transition frequencies.
 2. The limit decreases linearly with the logarithm of the frequency in the range of 0.15 to 0.50 MHz.

5.2 Test Instruments

Description & Manufacturer	Model No.	Serial No.	Cal. Date	Cal. Due
ROHDE & SCHWARZ Test Receiver	ESR3	102414	Jan. 5, 2021	Jan. 4, 2022
ROHDE & SCHWARZ Artificial Mains Network (for EUT)	ENV216	101197	Jun. 10, 2020	Jun. 9, 2021
LISN With Adapter (for EUT)	101197	NA	Jun. 10, 2020	Jun. 9, 2021
ROHDE & SCHWARZ Artificial Mains Network (for peripherals)	ESH3-Z5	100218	Dec. 2, 2020	Dec. 1, 2021
SCHWARZBECK Artificial Mains Network (For EUT)	NNLK8129	8129229	May 14, 2020	May 13, 2021
SCHWARZBECK Artificial Mains Network (for EUT)	NNLK 8121	8121-808	Apr. 10, 2020	Apr. 9, 2021
Software	Cond_V7.3.7.4	NA	NA	NA
RF cable (JYEBAO) With 10dB PAD	5D-FB	Cable-C10.01	Feb. 10, 2021	Feb. 9, 2022
LYNICS Terminator (For ROHDE & SCHWARZ LISN)	0900510	E1-011484	May 26, 2020	May 25, 2021

Note: 1. The calibration interval of the above test instruments is 12 months and the calibrations are traceable to NML/ROC and NIST/USA.
 2. The test was performed in Shielded Room No. 10. (Conduction 10)
 3. The VCCI Site Registration No. C-11852.
 4. Tested Date: Apr. 6, 2021

5.3 Test Arrangement

- The EUT was placed 0.4 meters from the conducting wall of the shielded room with EUT being connected to the power mains through a line impedance stabilization network (LISN). Other support units were connected to the power mains through another LISN. The two LISNs provide 50 Ohm/ 50uH of coupling impedance for the measuring instrument.
- Both lines of the power mains connected to the EUT were checked for maximum conducted interference.
- The test results of conducted emissions at mains ports are recorded of six worst margins for quasi-peak (mandatory) [and average (if necessary)] values against the limits at frequencies of interest unless the margin is 20 dB or greater.

Note: The resolution bandwidth and video bandwidth of test receiver is 9kHz for quasi-peak detection (QP) and average detection (AV) at frequency 0.15MHz-30MHz.

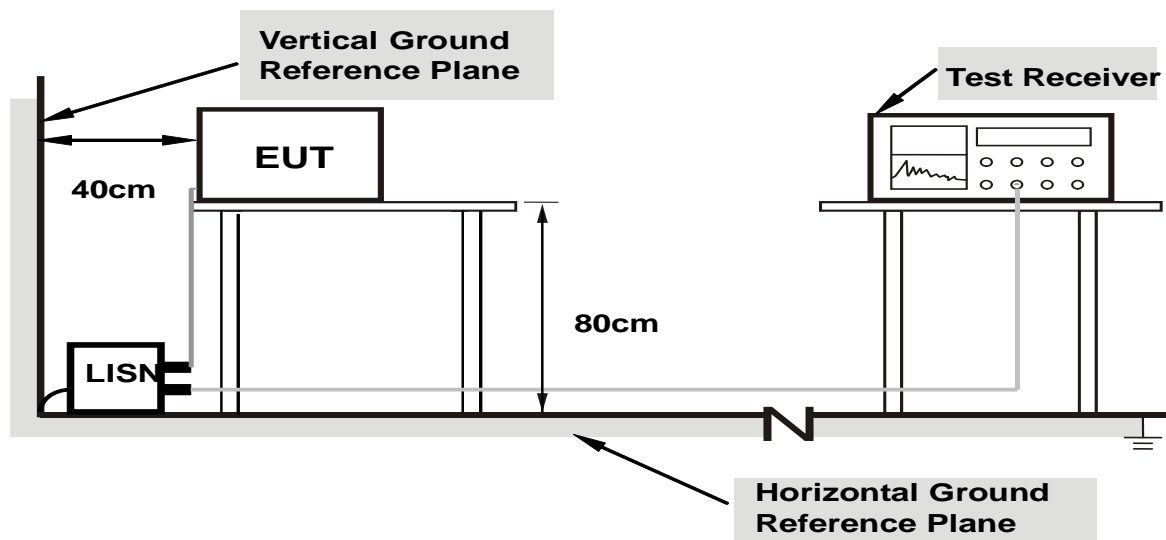

Note: Support units were connected to second LISN.

For the actual test configuration, please refer to the related item – Photographs of the Test Configuration.

5.4 Test Results

Frequency Range	150kHz ~ 30MHz	Detector Function & Bandwidth	Quasi-Peak (QP), 9kHz
Input Power	230Vac, 50Hz	Environmental Conditions	19°C, 70%RH
Tested by	Chin-Wen Wang	Test Date	2021/4/6
Test Mode	Mode 1		

Phase Of Power : Line (L)						
No	Frequency (MHz)	Correction Factor (dB)	Reading Value (dBuV)	Emission Level (dBuV)	Limit (dBuV)	Margin (dB)
			Q.P.	Q.P.	Q.P.	Q.P.
1	0.16564	9.72	38.32	48.04	99.00	-50.96
2	0.20866	9.72	39.52	49.24	99.00	-49.76
3	0.48635	9.72	41.13	50.85	99.00	-48.15
4	0.76790	9.74	40.49	50.23	93.00	-42.77
5	1.23136	9.76	38.38	48.14	93.00	-44.86
6	1.75543	9.78	35.02	44.80	93.00	-48.20

Remarks:

1. Q.P. and AV. are abbreviations of quasi-peak and average individually.
2. The emission levels of other frequencies were very low against the limit.
3. Margin value = Emission level – Limit value
4. Correction factor = Insertion loss + Cable loss
5. Emission Level = Correction Factor + Reading Value

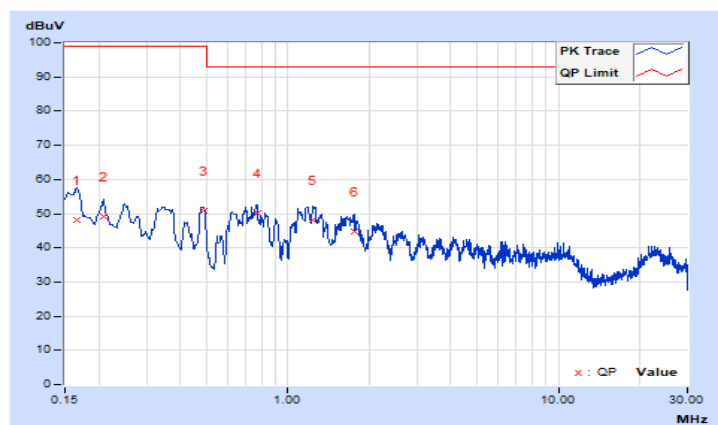

Frequency Range	150kHz ~ 30MHz	Detector Function & Bandwidth	Quasi-Peak (QP), 9kHz
Input Power	230Vac, 50Hz	Environmental Conditions	19°C, 70%RH
Tested by	Chin-Wen Wang	Test Date	2021/4/6
Test Mode	Mode 1		

Phase Of Power : Neutral (N)						
No	Frequency (MHz)	Correction Factor (dB)	Reading Value (dBuV)	Emission Level (dBuV)	Limit (dBuV)	Margin (dB)
			Q.P.	Q.P.	Q.P.	Q.P.
1	0.15000	9.72	39.47	49.19	99.00	-49.81
2	0.21059	9.72	39.12	48.84	99.00	-50.16
3	0.34926	9.72	40.99	50.71	99.00	-48.29
4	0.76185	9.74	40.04	49.78	93.00	-43.22
5	1.18443	9.76	39.16	48.92	93.00	-44.08
6	1.68112	9.78	35.66	45.44	93.00	-47.56

Remarks:

1. Q.P. and AV. are abbreviations of quasi-peak and average individually.
2. The emission levels of other frequencies were very low against the limit.
3. Margin value = Emission level – Limit value
4. Correction factor = Insertion loss + Cable loss
5. Emission Level = Correction Factor + Reading Value

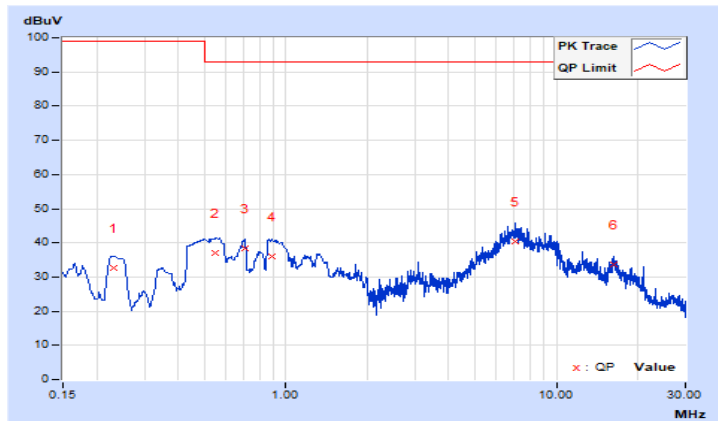

6 Radiated Disturbance up to 1 GHz

6.1 Limits

Frequency (MHz)	dBuV/m (at 10m) / quasi-peak
30 - 230	40
230 - 1000	47

- Notes:
1. The lower limit shall apply at the transition frequencies.
 2. Emission level (dBuV/m) = 20 log Emission level (uV/m).
 3. All emanations from a class A/B digital device or system, including any network of conductors and apparatus connected thereto, shall not exceed the level of field strengths specified above.

6.2 Test Instruments

Description & Manufacturer	Model No.	Serial No.	Cal. Date	Cal. Due
ROHDE & SCHWARZ TEST RECEIVER	ESCS 30	100027	May 19, 2020	May 18, 2021
Schwarzbeck Bilog Antenna	VULB9168	9168-303	Nov. 5, 2020	Nov. 4, 2021
Agilent Preamplifier	8447D	2944A08119	Feb. 18, 2021	Feb. 17, 2022
ADT. Turn Table	TT100	0205	NA	NA
ADT. Tower	AT100	0205	NA	NA
Software	Radiated_V7.6.15.9.5	NA	NA	NA
ADT RF Switches BOX	EMH-011	1001	Oct. 23, 2020	Oct. 22, 2021
Pacific RF cable With 5dB PAD	8D	CABLE-ST2-01	Oct. 23, 2020	Oct. 22, 2021

- Note:
1. The calibration interval of the above test instruments is 12 months and the calibrations are traceable to NML/ROC and NIST/USA.
 2. The test was performed in Open Site No. 2.
 3. The VCCI Site Registration No. R-10237.
 4. Tested Date: Apr. 1, 2021

6.3 Test Arrangement

- The EUT was placed on the top of a rotating table 0.8 meters above the ground at an accredited test facility. The table was rotated 360 degrees to determine the position of the highest radiation.
- The EUT was set 10 meters away from the interference-receiving antenna, which was mounted on the top of a variable-height antenna tower.
- The antenna is a broadband antenna, and its height is varied from one meter to four meters above the ground to determine the maximum value of the field strength. Both horizontal and vertical polarizations of the antenna are set to make the measurement.
- For each suspected emission, the EUT was arranged to its worst case and then the antenna was tuned to heights from 1 meter to 4 meters and the rotatable table was turned from 0 degrees to 360 degrees to find the maximum reading.
- The test-receiver system was set to quasi-peak detect function and specified bandwidth with maximum hold mode when the test frequency is up to 1 GHz.

Note: The resolution bandwidth and video bandwidth of test receiver/spectrum analyzer is 120kHz for quasi-peak detection (QP) at frequency up to 1GHz.

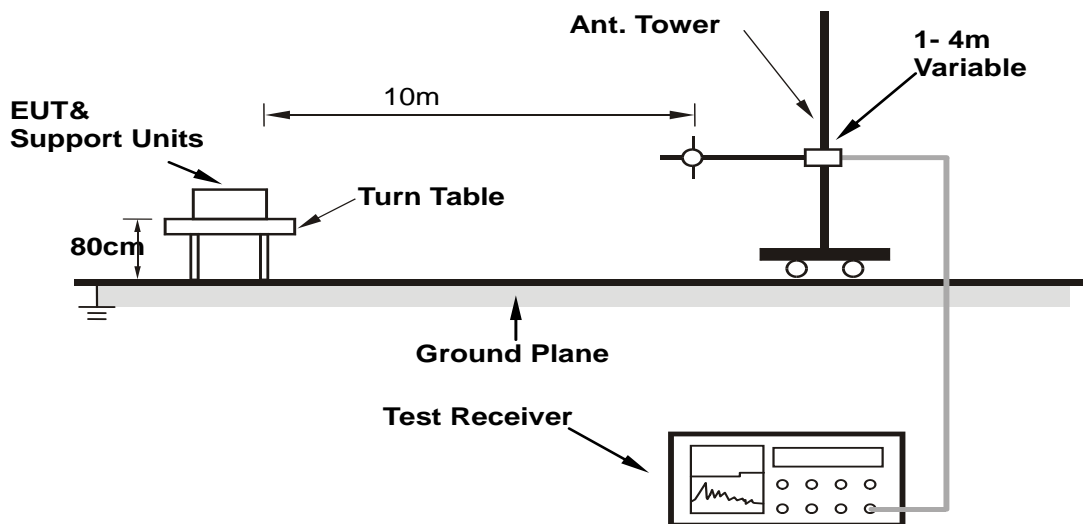

For the actual test configuration, please refer to the related item – Photographs of the Test Configuration.

6.4 Test Results

Frequency Range	30MHz ~ 1GHz	Detector Function & Resolution Bandwidth	Quasi-Peak (QP), 120kHz
Tested By	Paul Chen	Environmental Conditions	25.0°C, 77.0%RH
Test Mode	Mode 1	Test Date	2021/4/1

Antenna Polarity & Test Distance : Horizontal at 10 m								
No	Frequency (MHz)	Emission Level (dBuV/m)	Limit (dBuV/m)	Margin (dB)	Antenna Height (m)	Table Angle (Degree)	Raw Value (dBuV)	Correction Factor (dB/m)
1	51.13	25.48 QP	40.00	-14.52	4.00 H	329	35.43	-9.95
2	125.01	26.98 QP	40.00	-13.02	4.00 H	329	38.17	-11.19
3	172.36	30.89 QP	40.00	-9.11	4.00 H	360	40.59	-9.70
4	192.86	35.27 QP	40.00	-4.73	4.00 H	199	47.39	-12.12
5	220.53	30.02 QP	40.00	-9.98	4.00 H	348	41.81	-11.79
6	250.01	30.73 QP	47.00	-16.27	4.00 H	259	40.53	-9.80
7	500.01	31.69 QP	47.00	-15.31	1.98 H	245	35.17	-3.48
8	600.00	34.59 QP	47.00	-12.41	1.47 H	225	35.71	-1.12
9	999.58	36.73 QP	47.00	-10.27	1.00 H	23	30.13	6.60

Remarks:

1. Emission Level(dBuV/m) = Raw Value(dBuV) + Correction Factor(dB/m)
2. Correction Factor(dB/m) = Antenna Factor (dB/m) + Cable Factor (dB) – Pre-Amplifier Factor (dB)
3. The other emission levels were very low against the limit.
4. Margin value = Emission level – Limit value

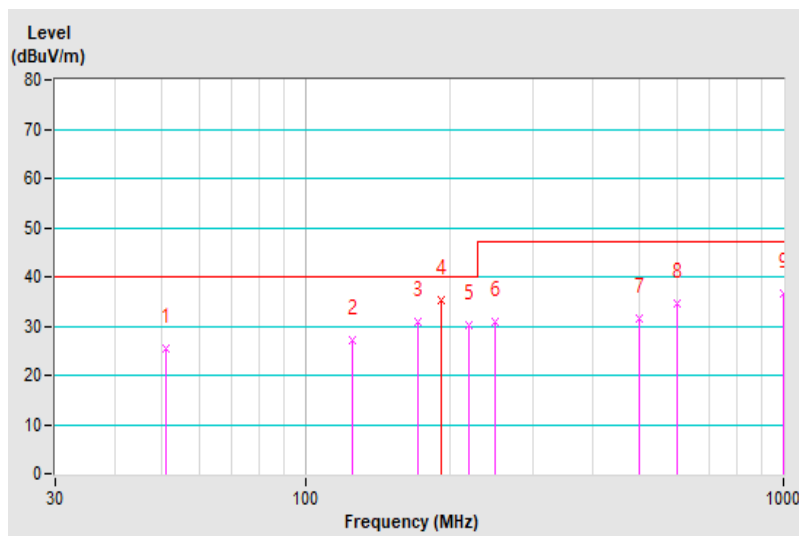

Frequency Range	30MHz ~ 1GHz	Detector Function & Resolution Bandwidth	Quasi-Peak (QP), 120kHz
Tested By	Paul Chen	Environmental Conditions	25.0°C, 77.0%RH
Test Mode	Mode 1	Test Date	2021/4/1

Antenna Polarity & Test Distance : Vertical at 10 m								
No	Frequency (MHz)	Emission Level (dBuV/m)	Limit (dBuV/m)	Margin (dB)	Antenna Height (m)	Table Angle (Degree)	Raw Value (dBuV)	Correction Factor (dB/m)
1	30.79	30.63 QP	40.00	-9.37	1.21 V	327	42.19	-11.56
2	56.13	26.69 QP	40.00	-13.31	1.63 V	224	36.93	-10.24
3	125.02	25.78 QP	40.00	-14.22	1.00 V	133	36.97	-11.19
4	193.23	35.09 QP	40.00	-4.91	1.00 V	246	47.23	-12.14
5	209.87	30.93 QP	40.00	-9.07	1.00 V	345	43.15	-12.22
6	250.01	31.19 QP	47.00	-15.81	1.00 V	173	40.99	-9.80
7	499.99	31.18 QP	47.00	-15.82	1.00 V	193	34.66	-3.48
8	599.98	39.27 QP	47.00	-7.73	3.39 V	186	40.39	-1.12
9	999.82	33.56 QP	47.00	-13.44	2.17 V	313	26.96	6.60

Remarks:

1. Emission Level(dBuV/m) = Raw Value(dBuV) + Correction Factor(dB/m)
2. Correction Factor(dB/m) = Antenna Factor (dB/m) + Cable Factor (dB) – Pre-Amplifier Factor (dB)
3. The other emission levels were very low against the limit.
4. Margin value = Emission level – Limit value

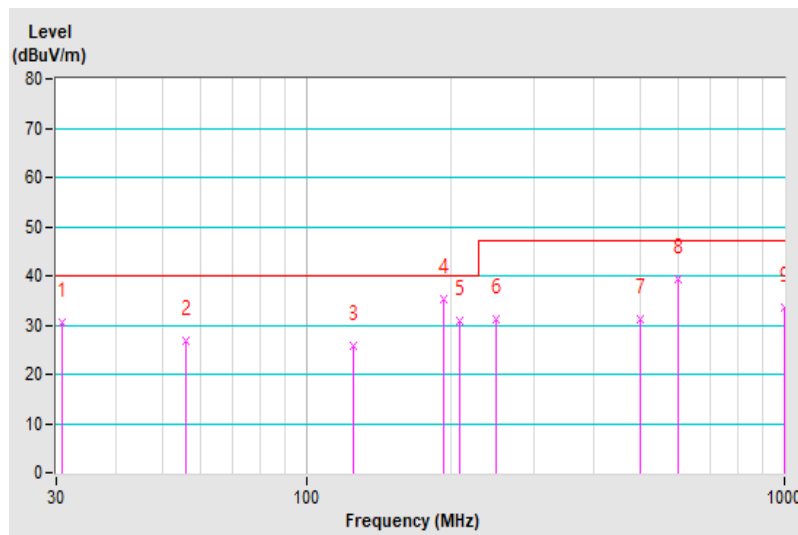

7 Radiated Disturbance above 1 GHz

7.1 Limits

Frequency (GHz)	dBuV/m (at 3m)	
	Average	Peak
1 to 3	56	76
3 to 6	60	80

- Notes: 1. The lower limit shall apply at the transition frequencies.
 2. Emission level (dBuV/m) = 20 log Emission level (uV/m).
 3. All emanations from a class A/B digital device or system, including any network of conductors and apparatus connected thereto, shall not exceed the level of field strengths specified above.

Frequency Range (For unintentional radiators)

Highest frequency generated or used in the EUT or on which the EUT operates or tunes (MHz)	Upper frequency of measurement range (MHz)
Below 108	1000
108-500	2000
500-1000	5000
Above 1000	Up to 5 times of the highest frequency or 6 GHz, whichever is less

7.2 Test Instruments

Description & Manufacturer	Model No.	Serial No.	Cal. Date	Cal. Due
Agilent Spectrum	E4446A	MY51100009	Jun. 23, 2020	Jun. 22, 2021
Agilent Preamplifier	8449B	3008A01292	Feb. 19, 2021	Feb. 18, 2022
MITEQ Preamplifier	AMF-6F-260400-33-8P	892164	Feb. 19, 2021	Feb. 18, 2022
EMCI Preamplifier	EMC184045B	980235	Feb. 19, 2021	Feb. 18, 2022
ETS Preamplifier	3117-PA	00215857	Nov. 23, 2020	Nov. 22, 2021
Schwarzbeck Horn Antenna	BBHA-9170	212	Nov. 22, 2020	Nov. 21, 2021
EMCO Horn Antenna	3115	6714	Nov. 22, 2020	Nov. 21, 2021
Max Full. Turn Table	MF7802	MF780208216	NA	NA
Software	Radiated_V8.7.08	NA	NA	NA
KIK + WOKEN RF cable With 3/4dB PAD	K1K50-UP0279-K1K50-3000+WC01	Cable-CH10(3m)-04 +Cable-CH10-03	Jul. 9, 2020	Jul. 8, 2021
MICRO-TRONICS Notch filter	BRC50703-01	010	May 29, 2020	May 28, 2021
MICRO-TRONICS Band Pass Filter	BRM17690	005	May 29, 2020	May 28, 2021

- Note: 1. The calibration interval of the above test instruments is 12 months and the calibrations are traceable to NML/ROC and NIST/USA.
 2. The 3dB beamwidth of the horn antenna is minimum 41degree (or w = 2.24m at 3m distance) for 1~6 GHz.
 3. The test was performed in Chamber No. 10.
 4. The VCCI Site Registration No. G-10427
 5. Tested Date: Apr. 6, 2021

7.3 Test Arrangement

- The EUT was placed on the top of a rotating table 0.8 meters above the ground at an accredited chamber room. The table was rotated 360 degrees to determine the position of the highest radiation.
- The EUT was set 3 meters away from the interference-receiving antenna, which was mounted on the top of a variable-height antenna tower.
- The height of antenna can be varied from one meter to four meters, the height of adjustment depends on the EUT height and the antenna 3dB beamwidth both, to detect the maximum value of the field strength. Both horizontal and vertical polarizations of the antenna are set to make the measurement.
- For each suspected emission, the EUT was arranged to its worst case and then the antenna was tuned to heights and the rotatable table was turned from 0 degrees to 360 degrees to find the maximum reading.
- The spectrum analyzer system was set to peak and average detect function and specified bandwidth with maximum hold mode when the test frequency is above 1 GHz.

Note: The resolution bandwidth of test receiver/spectrum analyzer is 1MHz and video bandwidth is 3MHz for Peak detection (PK) at frequency above 1GHz. The resolution bandwidth of test receiver/spectrum analyzer is 1 MHz for Average detection (AV) at frequency above 1GHz.

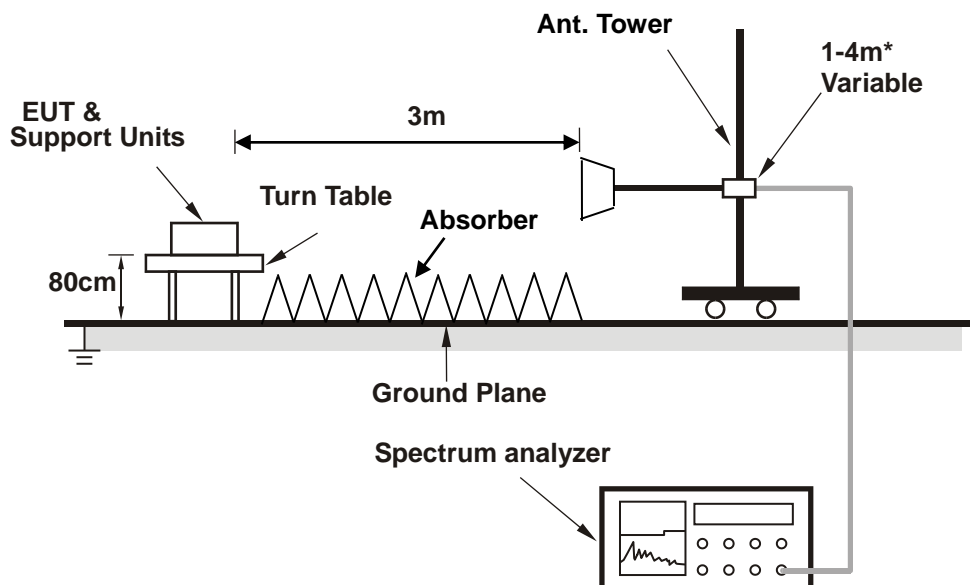

* :depends on the EUT height and the antenna 3dB beamwidth both.

For the actual test configuration, please refer to the related item – Photographs of the Test Configuration.

7.4 Test Results

Frequency Range	1GHz ~ 6GHz	Detector Function & Resolution Bandwidth	Peak (PK) / Average (AV), 1MHz
Tested By	Paul Chen	Environmental Conditions	24.0°C, 70.0%RH
Test Mode	Mode 1	Test Date	2021/4/6

Antenna Polarity & Test Distance : Horizontal at 3 m								
No	Frequency (MHz)	Emission Level (dBuV/m)	Limit (dBuV/m)	Margin (dB)	Antenna Height (m)	Table Angle (Degree)	Raw Value (dBuV)	Correction Factor (dB/m)
1	1363.74	52.75 PK	76.00	-23.25	1.11 H	233	57.76	-5.01
2	1363.74	38.33 AV	56.00	-17.67	1.11 H	233	43.34	-5.01
3	3999.97	55.45 PK	80.00	-24.55	1.27 H	120	52.43	3.02
4	3999.97	48.98 AV	60.00	-11.02	1.27 H	120	45.96	3.02
5	5399.94	56.77 PK	80.00	-23.23	1.35 H	129	51.73	5.04
6	5399.94	52.51 AV	60.00	-7.49	1.35 H	129	47.47	5.04

Remarks:

1. Emission Level(dBuV/m) = Raw Value(dBuV) + Correction Factor(dB/m)
2. Correction Factor(dB/m) = Antenna Factor (dB/m) + Cable Factor (dB) – Pre-Amplifier Factor (dB)
3. The other emission levels were very low against the limit.
4. Margin value = Emission level – Limit value

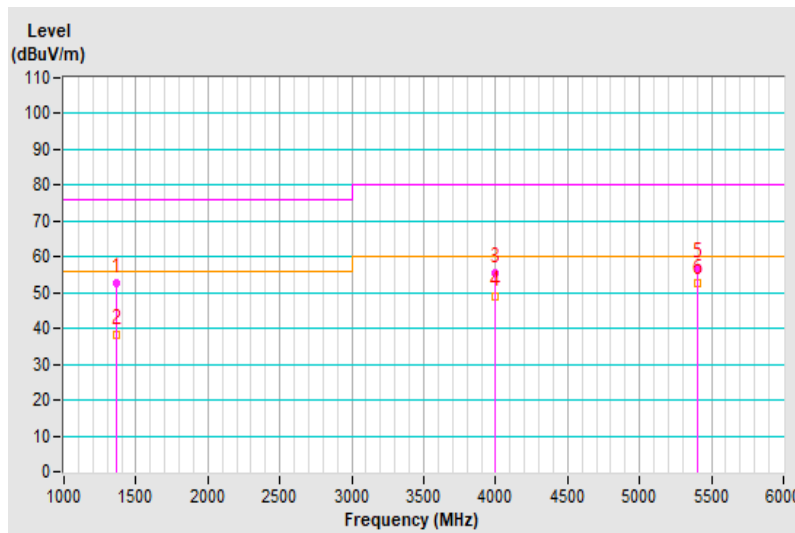

Frequency Range	1GHz ~ 6GHz	Detector Function & Resolution Bandwidth	Peak (PK) / Average (AV), 1MHz
Tested By	Paul Chen	Environmental Conditions	24.0°C, 70.0%RH
Test Mode	Mode 1	Test Date	2021/4/6

Antenna Polarity & Test Distance : Vertical at 3 m								
No	Frequency (MHz)	Emission Level (dBuV/m)	Limit (dBuV/m)	Margin (dB)	Antenna Height (m)	Table Angle (Degree)	Raw Value (dBuV)	Correction Factor (dB/m)
1	1363.80	52.33 PK	76.00	-23.67	2.27 V	204	57.34	-5.01
2	1363.80	37.51 AV	56.00	-18.49	2.27 V	204	42.52	-5.01
3	3999.98	52.69 PK	80.00	-27.31	2.18 V	140	49.67	3.02
4	3999.98	45.02 AV	60.00	-14.98	2.18 V	140	42.00	3.02
5	5399.90	56.19 PK	80.00	-23.81	1.55 V	113	51.15	5.04
6	5399.90	50.78 AV	60.00	-9.22	1.55 V	113	45.74	5.04

Remarks:

1. Emission Level(dBuV/m) = Raw Value(dBuV) + Correction Factor(dB/m)
2. Correction Factor(dB/m) = Antenna Factor (dB/m) + Cable Factor (dB) – Pre-Amplifier Factor (dB)
3. The other emission levels were very low against the limit.
4. Margin value = Emission level – Limit value

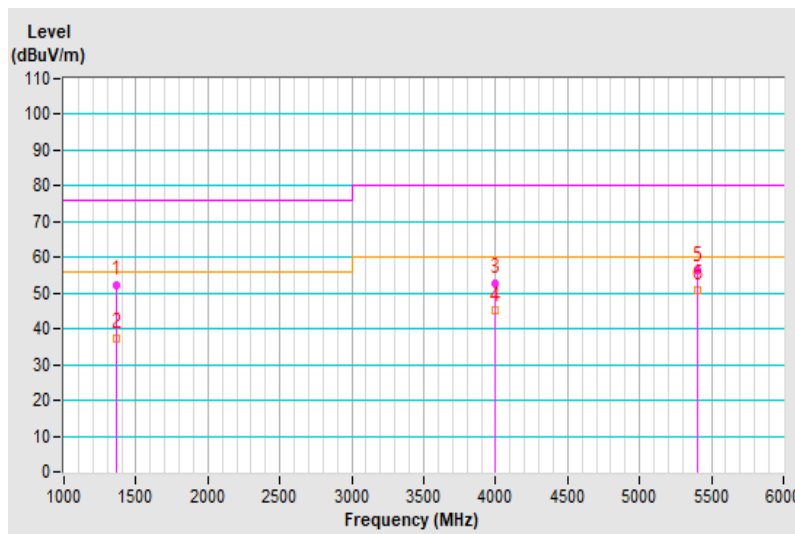

8 Harmonics Current Measurement

8.1 Limits

Limits for Class A equipment		Limits for Class D equipment		
Harmonic Order n	Max. permissible harmonics current A	Harmonic Order n	Max. permissible harmonics current per watt mA/W	Max. permissible harmonics current A
Odd harmonics		Odd Harmonics only		
3	2.30	3	3.4	2.30
5	1.14	5	1.9	1.14
7	0.77	7	1.0	0.77
9	0.40	9	0.5	0.40
11	0.33	11	0.35	0.33
13	0.21	13	0.30	0.21
15 ≤ n ≤ 39	0.15 x 15/n	15 ≤ n ≤ 39	3.85/n	0.15 x 15/n
Even harmonics				
2	1.08			
4	0.43			
6	0.30			
8 ≤ n ≤ 40	0.23 x 8/n			

- Notes: 1. Class A and Class D are classified according to section 5 of EN 61000-3-2.
 2. According to section 7 of EN 61000-3-2, the above limits for all equipment except for lighting equipment having an active input power > 75 W and no limits apply for equipment with an active input power up to and including 75 W.

8.2 Classification of Equipment

Class A	Class B	Class C	Class D
Balanced three-phase equipment; Household appliances excluding equipment as Class D; Tools excluding portable tools; Dimmers for incandescent lamps; Audio equipment; Equipment not specified in one of the three other classes.	Portable tools; Arc welding equipment which is not professional equipment.	Lighting equipment.	Equipment having a specified power less than or equal to 600 W of the following types: Personal computers and personal computer monitors; Television receivers; Refrigerators and freezers having one or more variable-speed drives to control compressor motor(s).

8.3 Test Instruments

Description & Manufacturer	Model No.	Serial No.	Cal. Date	Cal. Due
Teseq Harmonics - Flicker Test System	Proflin 2105	32A00983 & 1639A01863	Sep. 16, 2020	Sep. 15, 2021
Software	CTS 4	NA	NA	NA

- Note: 1. The calibration interval of the above test instruments is 12 months and the calibrations are traceable to NML/ROC and NIST/USA.
 2. The test was performed in EMS Room No. 1.
 3. According to IEC 61000-4-7: 2002, the time window shall be synchronized with each group of 10 or 12 cycles (200 ms) for power frequency of 50 or 60Hz.
 4. Tested Date: Apr. 8, 2021

8.4 Test Arrangement

- a. The EUT was placed on the top of a wooden table 0.8 meters above the ground and operated to produce the maximum harmonic components under normal operating conditions for each successive harmonic component in turn.
- b. The correspondent test program of test instrument to measure the current harmonics emanated from EUT is chosen. The measure time shall be not less than the time necessary for the EUT to be exercised.

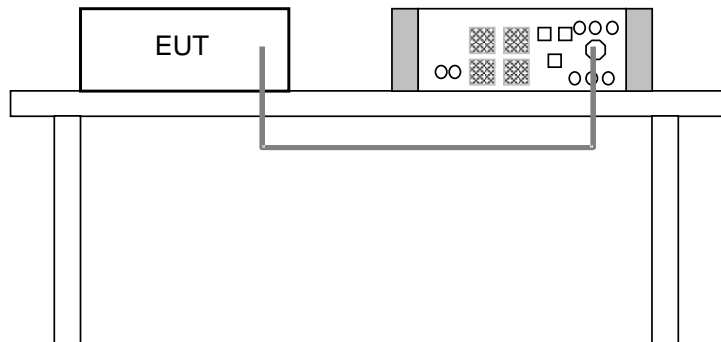

For the actual test configuration, please refer to the related item – Photographs of the Test Configuration.

8.5 Test Results

Fundamental Voltage/Ampere	230.55Vrms/ 0.360Arms	Power Frequency	50.00Hz
Power Consumption	64.7W	Power Factor	0.893
Environmental Conditions	22°C, 80% RH	Tested by	Bernie Lu
Test Mode	Mode 1	Test Date	2021/4/8

- Note:
1. Limits are not specified for equipment with a rated power of 75W or less (other than lighting equipment).
 2. According to EN 61000-3-2 the manufacturer shall specify the power of the apparatus. This value shall be used for establishing limits. The specified power shall be within +/-10% of the measured power.

9 Voltage Fluctuations and Flicker Measurement

9.1 Limits

Test item	Limit	Note
P_{st}	1.0	P_{st} : short-term flicker severity.
P_{lt}	0.65	P_{lt} : long-term flicker severity.
T_{max} (ms)	500	T_{max} : maximum time duration during the observation period that the voltage deviation $d(t)$ exceeds the limit for d_c .
d_{max} (%)	4	d_{max} : maximum absolute voltage change during an observation period.
d_c (%)	3.3	d_c : maximum steady state voltage change during an observation period.

9.2 Test Instruments

Description & Manufacturer	Model No.	Serial No.	Cal. Date	Cal. Due
Teseq Harmonics - Flicker Test System	Proflin 2105	32A00983 & 1639A01863	Sep. 16, 2020	Sep. 15, 2021
Software	CTS 4	NA	NA	NA

Note: 1. The calibration interval of the above test instruments is 12 months and the calibrations are traceable to NML/ROC and NIST/USA.
 2. The test was performed in EMS Room No. 1.
 3. Tested Date: Apr. 8, 2021

9.3 Test Arrangement

- The EUT was placed on the top of a wooden table 0.8 meters above the ground and operated to produce the most unfavorable sequence of voltage changes under normal operating conditions.
- During the flick measurement, the measure time shall include that part of whole operation cycle in which the EUT produce the most unfavorable sequence of voltage changes. The observation period for short-term flicker indicator is 10 minutes and the observation period for long-term flicker indicator is 2 hours.

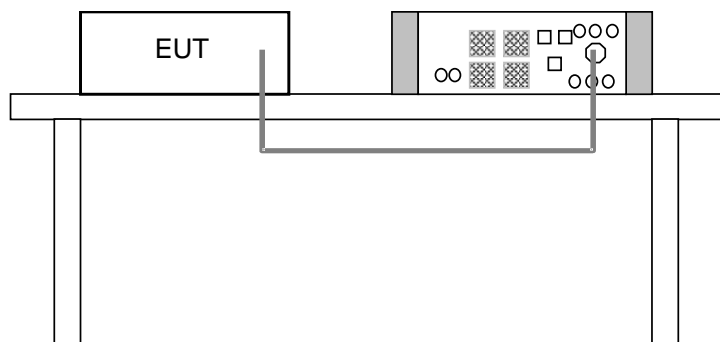

For the actual test configuration, please refer to the related item – Photographs of the Test Configuration.

9.4 Test Results

Fundamental Voltage/Ampere	230.55Vrms/ 0.360Arms	Power Frequency	50.00Hz
Observation (T_p)	10 min.	Power Factor	0.893
Environmental Conditions	22°C, 80% RH	Tested by	Bernie Lu
Test Mode	Mode 1	Test Date	2021/4/8

Test Parameter	Measurement Value	Limit	Remarks
P_{st}	0.064	1.00	Pass
P_{lt}	0.028	0.65	Pass
T_{max} (ms)	0	500	Pass
d_{max} (%)	0	4	Pass
d_c (%)	0	3.3	Pass

- Note: (1) P_{st} means short-term flicker indicator.
 (2) P_{lt} means long-term flicker indicator.
 (3) T_{max} means accumulated time value of $d(t)$ with a deviation exceeding 3.3 %.
 (4) d_{max} means maximum relative voltage change.
 (5) d_c means maximum relative steady-state voltage change.

10 Electrostatic Discharge Immunity Test (ESD)

10.1 Test Specification

Basic Standard:	EN 61000-4-2
Discharge Impedance:	330 ohm / 150 pF
Discharge Voltage:	Air Discharge: ± 2 , ± 4 , ± 8 kV (Direct) Contact Discharge: ± 2 , ± 4 , ± 6 kV (Indirect & Direct)
Number of Discharge:	Minimum 20 times at each test point
Discharge Mode:	Single Discharge
Discharge Period:	1-second minimum

10.2 Test Instruments

Description & Manufacturer	Model No.	Serial No.	Cal. Date	Cal. Due
KeyTek, ESD Simulator	MZ-15/EC	0401299	Oct. 7, 2020	Oct. 6, 2021

- Note:
1. The calibration interval of the above test instruments is 12 months and the calibrations are traceable to NML/ROC and NIST/USA.
 2. The test was performed in ESD Room No. 3.
 3. Tested Date: Apr. 9, 2021

10.3 Test Arrangement

- a. Electrostatic discharges were applied only to those points and surfaces of the EUT that are accessible to users during normal operation.
- b. The test was performed with at least ten single discharges on the pre-selected points in the most sensitive polarity.
- c. The time interval between two successive single discharges was at least 1 second.
- d. The ESD generator was held perpendicularly to the surface to which the discharge was applied and the return cable was at least 0.2 meters from the EUT.
- e. Contact discharges were applied to the non-insulating coating, with the pointed tip of the generator penetrating the coating and contacting the conducting substrate.
- f. Air discharges were applied with the round discharge tip of the discharge electrode approaching the EUT as fast as possible (without causing mechanical damage) to touch the EUT. After each discharge, the ESD generator was removed from the EUT and re-triggered for a new single discharge. The test was repeated until all discharges were complete.
- g. At least ten single discharges (in the most sensitive polarity) were applied to the **Horizontal Coupling Plane** at points on each side of the EUT. The ESD generator was positioned at a distance of 0.1 meters from the EUT with the discharge electrode touching the **HCP**.
- h. At least ten single discharges (in the most sensitive polarity) were applied to the center of one vertical edge of the **Vertical Coupling Plane** in sufficiently different positions that the four faces of the EUT were completely illuminated. The **VCP** (dimensions 0.5m x 0.5m) was placed vertically to and 0.1 meters from the EUT.

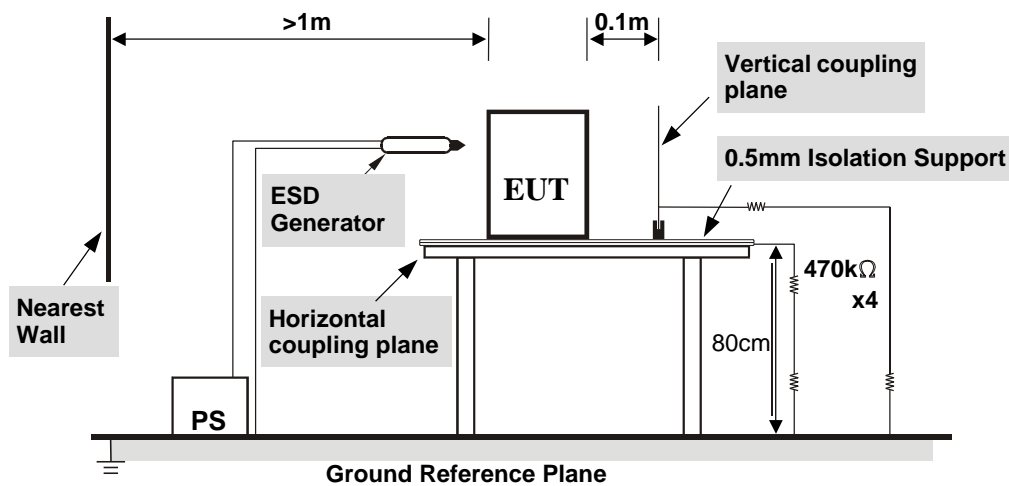

TABLE-TOP EQUIPMENT

The configuration consisted of a wooden table 0.8 meters high standing on the **Ground Reference Plane**. The **GRP** consisted of a sheet of aluminum at least 0.25mm thick, and 2.5 meters square connected to the protective grounding system. A **Horizontal Coupling Plane** (1.6m x 0.8m) was placed on the table and attached to the **GRP** by means of a cable with 940kΩ total impedance. The equipment under test, was installed in a representative system as described in section 7 of EN 61000-4-2, and its cables were placed on the **HCP** and isolated by an insulating support of 0.5mm thickness. A distance of 1-meter minimum was provided between the EUT and the walls of the laboratory and any other metallic structure.

For the actual test configuration, please refer to the related item – Photographs of the Test Configuration.

10.4 Test Results

Input Power	230 Vac, 50 Hz	Tested by	Xun Lee
Environmental conditions	22 °C, 49% RH 1012 mbar	Test Date	2021/4/9
Test mode	Mode 1		

Test Results of Direct Application

Discharge Level (kV)	Polarity (+/-)	Test Point	Contact Discharge	Air Discharge	Performance Criterion
2	+/-	1-6	Note 1	NA	A
4, 6	+/-	1-6	Note 2	NA	B
2, 4, 8	+/-	7-10	NA	Note 1	A
2, 4	+/-	11, 12	NA	Note 1	A
8	+/-	11, 12	NA	Note 2	B

Description of test points of direct application: Please refer to following page for representative mark only.

Test Results of Indirect Application

Discharge Level (kV)	Polarity (+/-)	Test Point	Horizontal Coupling Plane	Vertical Coupling Plane	Performance Criterion
2, 4	+/-	Four Sides	Note 1	Note 1	A
6	+/-	Four Sides	Note 2	Note 2	B

Description of test points of indirect application:

1. Front side
2. Rear side
3. Right side
4. Left side

Note: 1. The EUT function was correct during the test.
 2. There was horizontal bars on the screen during the test, but self-recoverable after the test.

Description of Test Points

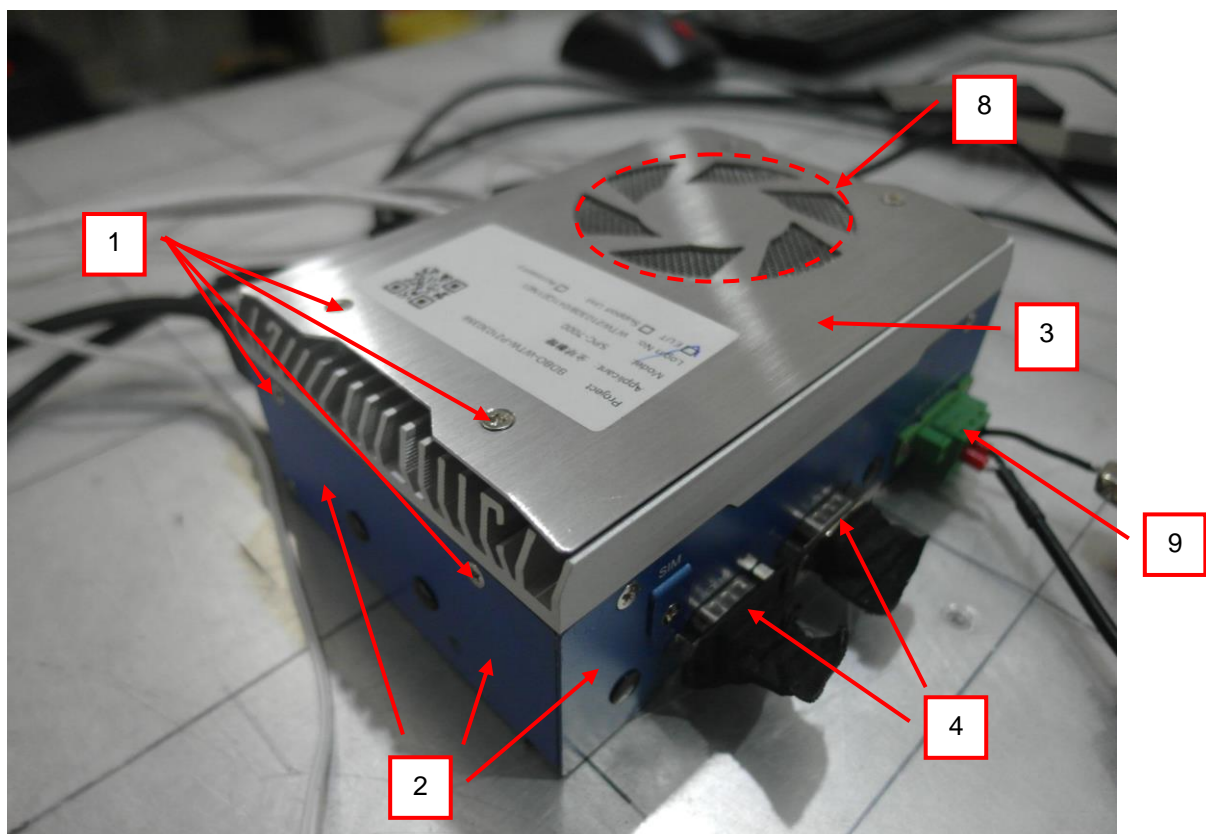
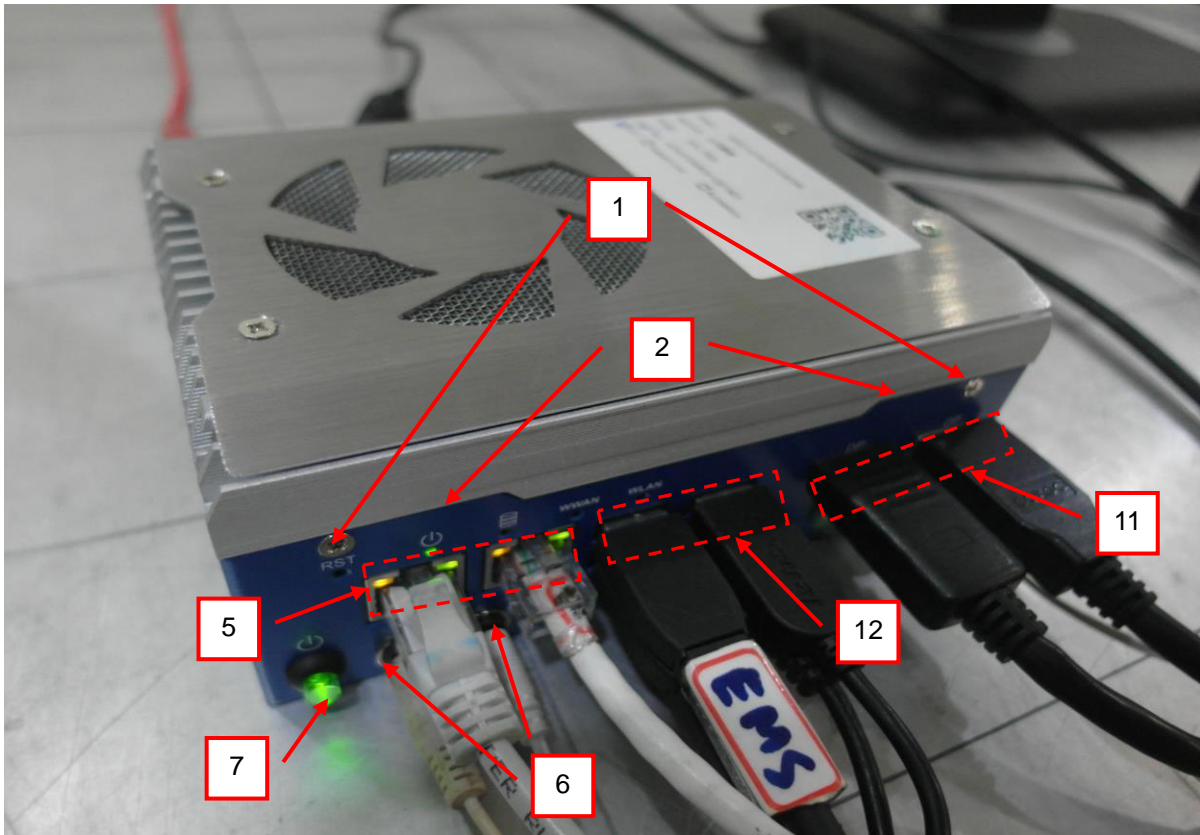



11 Radio-frequency Electromagnetic Field Immunity Test (RS)

11.1 Test Specification

Basic Standard:	EN 61000-4-3
Frequency Range, Field Strength:	80-800 MHz, 20V/m ¹
	800-1000 MHz, 20V/m
	1400-2000 MHz, 10V/m
	2000-2700 MHz, 5V/m
Modulation:	5100-6000 MHz, 3V/m
	1kHz Sine Wave, 80%, AM Modulation
Frequency Step:	1 % of preceding frequency value
Polarity of Antenna:	Horizontal and Vertical
Antenna Height:	1.5m
Dwell Time:	3 seconds

Note 1: This limit applies to equipment mounted in the passenger compartments, drivers cab or external to the rolling stock (roof, underframe). For equipment mounted in all other areas a severity level of 10 V/m may be used.

11.2 Test Instruments

Description & Manufacturer	Model No.	Serial No.	Cal. Date	Cal. Due
AgilentSignal Generator	E8257D	MY48050465	Jun. 8, 2020	Jun. 7, 2021
BONN RF Amplifier	BSA 0125-800	1912556	NA	NA
TESTQAmplifier	CBA 1G-275	T44344	NA	NA
AR RF Amplifier	35S4G8AM4	0326094	NA	NA
AR RF Amplifier	100S1G4M3	0329249	NA	NA
AR Controller	SC1000M3	305910	NA	NA
ARLog-Periodic Antenna	AT6080	0329465	NA	NA
BOONTON RF Voltage Meter	4232A	10180	May 29, 2020	May 28, 2021
BOONTON Power Sensor	51011-EMC	34152	May 29, 2020	May 28, 2021
BOONTON Power Sensor	51011-EMC	34153	May 29, 2020	May 28, 2021
EMCO BiconiLog Antenna	3141	1001	NA	NA
ARHigh Gain Antenna	AT4010	0329800	NA	NA
SchwarzbeckLOG ANTENNA	Stlp 9149	9149-260	NA	NA
CHANCE MOST Full Anechoic Chamber (9x5x3m)	Chance Most	RS-002	Feb. 4, 2021	Feb. 3, 2022
Software	RS_V7.6	NA	NA	NA

- Note:
1. The calibration interval of the above test instruments is 12 months and the calibrations are traceable to NML/ROC and NIST/USA.
 2. The test was performed in RS Room No.2.
 3. The transmit antenna was located at a distance of 3 meters from the EUT.
 4. Tested Date: Apr. 22, 2021

11.3 Test Arrangement

The test procedure was in accordance with EN 61000-4-3.

- a. The testing was performed in a fully anechoic chamber.
- b. The frequency ranges and field strength levels are 80-800 MHz, 20V/m, 800-1000 MHz, 20V/m, 1400-2000 MHz, 10V/m, 2000-2700 MHz, 5V/m and 5100-6000 MHz, 3V/m with the signal 80% amplitude modulated with a 1kHz sine wave.
- c. The test was performed with the EUT exposed to both vertically and horizontally polarized fields on each of the four sides.

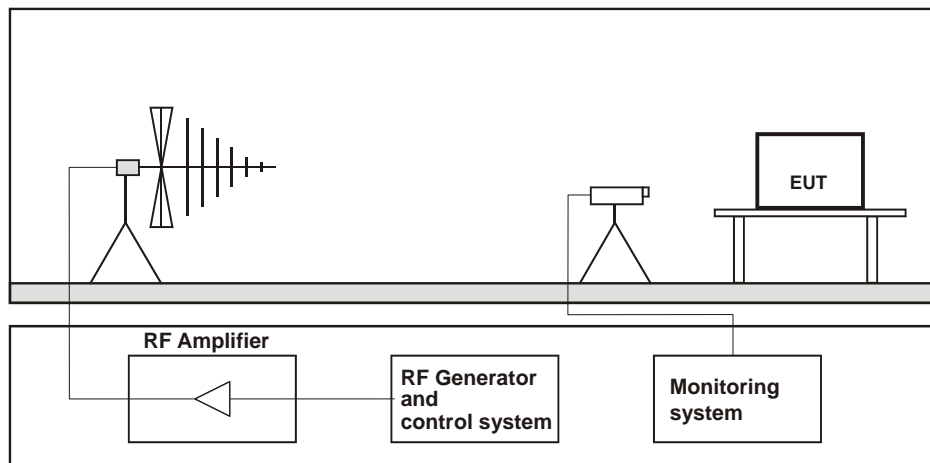

Table-top Equipment

The EUT installed in a representative system as described in section 7 of EN 61000-4-3 was placed on a non-conductive table 0.8 meters in height. The system under test was connected to the power and signal wire according to relevant installation instructions.

For the actual test configuration, please refer to the related item – Photographs of the Test Configuration.

11.4 Test Results

Input Power	230 Vac, 50 Hz	Tested by	Sean Chou
Environmental conditions	23 °C, 70% RH	Test Date	2021/4/22
Test mode	Mode 1		

Frequency (MHz)	Polarity	Azimuth(°)	Applied Field Strength		Observation	Test Distance (m)	Performance Criterion
			(V/m)	Modulation			
80 - 800	V&H	0, 90, 180, 270	20	80% AM (1kHz)	Note	1.5	A
800 - 1000	V&H	0, 90, 180, 270	20	80% AM (1kHz)	Note	1.5	A
1400 - 2000	V&H	0, 90, 180, 270	10	80% AM (1kHz)	Note	3	A
2000 - 2700	V&H	0, 90, 180, 270	5	80% AM (1kHz)	Note	3	A
5100 - 6000	V&H	0, 90, 180, 270	3	80% AM (1kHz)	Note	3	A

Note: The EUT function was correct during the test.

12 Electrical Fast Transient/Burst Immunity Test (EFT)

12.1 Test Specification

Basic Standard:	EN 61000-4-4
Test Voltage:	Signal & communication, process measurement & control ports: $\pm 2\text{kV}$, Capacitive clamp Battery referenced ports (except at the output of energy sources), Auxiliary a.c. power input ports (rated voltage $\leq 400\text{ Vrms}$): $\pm 2\text{kV}$
Impulse Repetition Frequency:	5kHz
Impulse Wave Shape:	5/50 (T_r/T_h) ns
Burst Duration:	15 ms
Burst Period:	300 ms
Test Duration:	1 min.

12.2 Test Instruments

Description & Manufacturer	Model No.	Serial No.	Cal. Date	Cal. Due
Haefely, EFT Generator	PEFT 4010	154954	Apr. 20, 2020	Apr. 19, 2021
Haefely, Capacitive Clamp	IP4A	155173	Apr. 20, 2020	Apr. 19, 2021

- Note:
1. The calibration interval of the above test instruments is 12 months and the calibrations are traceable to NML/ROC and NIST/USA.
 2. The test was performed in EFT Room.
 3. Tested Date: Mar. 24, 2021

12.3 Test Arrangement

- Both positive and negative polarity discharges were applied.
- The distance between any coupling devices and the EUT should be 0.5 m for table-top equipment testing, and 1.0 m for floor standing equipment.
- The duration time of each test sequential was 1 minute.
- The transient/burst waveform was in accordance with EN 61000-4-4, 5/50 ns.

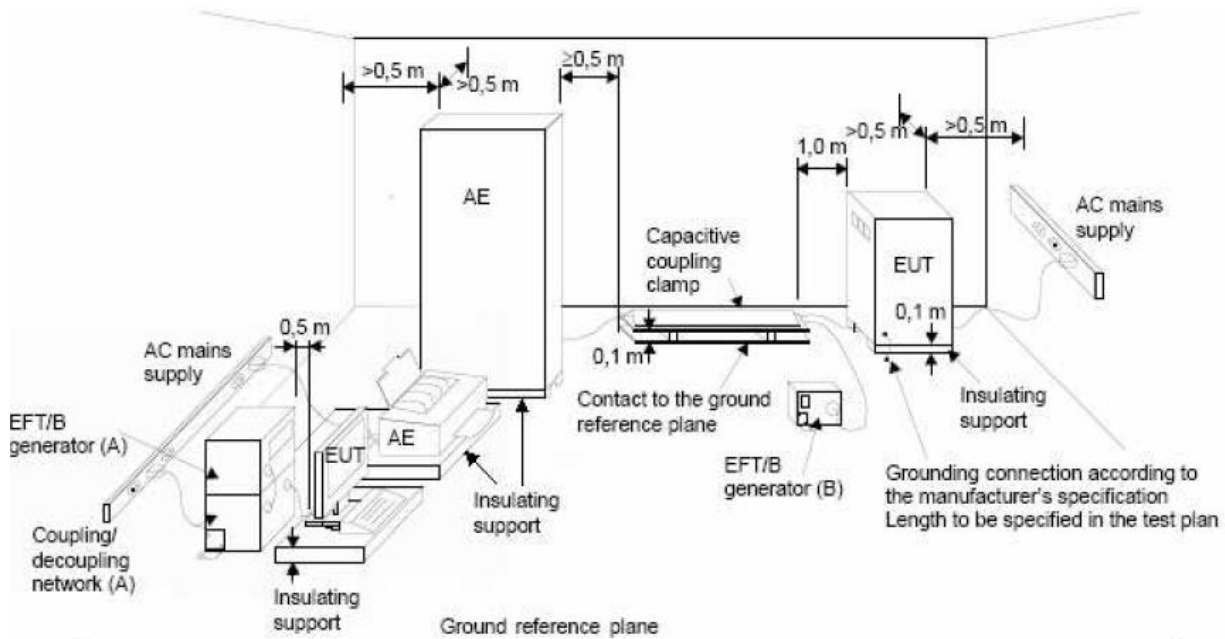

NOTE:

- location for supply line coupling
- location for signal lines coupling

For the actual test configuration, please refer to the related item – Photographs of the Test Configuration.

12.4 Test Results

Input Power	230 Vac, 50 Hz	Tested by	Thomas Cheng
Environmental conditions	20 °C, 69% RH	Test Date	2021/3/24
Test mode	Mode 1		

Battery referenced ports (except at the output of energy sources),
 Auxiliary a.c. power input ports (rated voltage \leq 400 Vrms)

Voltage (kV)	Test Point	Polarity (+/-)	Observation	Performance Criterion
2	L1	+/-	Note	A
2	L2	+/-	Note	A
2	PE	+/-	Note	A
2	L1-L2- PE	+/-	Note	A

Signal & communication, process measurement & control ports

Voltage (kV)	Test Point	Polarity (+/-)	Observation	Performance Criterion
2	LAN (Port 1, 2)	+/-	Note	A

Note: The EUT function was correct during the test.

13 Surge Immunity Test

13.1 Test Specification

Basic Standard:	EN 61000-4-5
Wave-Shape:	Battery referenced ports (except at the output of energy sources), Auxiliary a.c. power input ports (rated voltage ≤ 400 Vrms): 1.2/50 μ s Open Circuit Voltage 8/20 μ s Short Circuit Current
Test Voltage:	Line to line: ± 0.5 kV, ± 1 kV, Line to ground: ± 0.5 kV, ± 1 kV, ± 2 kV output impedance of 42 Ω (40 Ω and 2 Ω generator) and a coupling capacitance of 0,5 μ F
AC Phase Angle (degree):	0°, 90°, 180°, 270°
Pulse Repetition Rate:	1 time / 20 sec.
Number of Tests:	5 positive and 5 negative at selected points

13.2 Test Instruments

Description & Manufacturer	Model No.	Serial No.	Cal. Date	Cal. Due
TESEQ, Surge Simulator	NSG 3060	1572	May 12, 2020	May 11, 2021
TESEQ, CDN	CDN 3083-100	1215	May 12, 2020	May 11, 2021
Coupling Decoupling Network	CDN-UTP8	045	Aug. 18, 2020	Aug. 17, 2021
TESEQ Coupling Decoupling Network	CDN HSS-2	41009	May 12, 2020	May 11, 2021
TESEQ Coupling Decoupling Network	CDN 118-T8	40386	Sep. 8, 2020	Sep. 7, 2021
TESEQ CDN for Unshielded Unsymmetrical Signal & Data Lines	CDN117	40144	Sep. 8, 2020	Sep. 7, 2021

- Note:
1. The calibration interval of the above test instruments is 12 months and the calibrations are traceable to NML/ROC and NIST/USA.
 2. The test was performed in EMS Room No. 2.
 3. Tested Date: Apr. 8, 2021

13.3 Test Arrangement

The surge is to be applied to the EUT power supply terminals via the capacitive coupling network. Decoupling networks are required in order to avoid possible adverse effects on equipment not under test that may be powered by the same lines, and to provide sufficient decoupling impedance to the surge wave. The power cord between the EUT and the coupling/decoupling networks shall be 2 meters in length (or shorter).

For double-insulated products without PE or external earth connections, the test shall be done in a similar way as for grounded products but without adding any additional external grounded connections. If there are no other possible connections to earth, line-to-ground tests may be omitted.

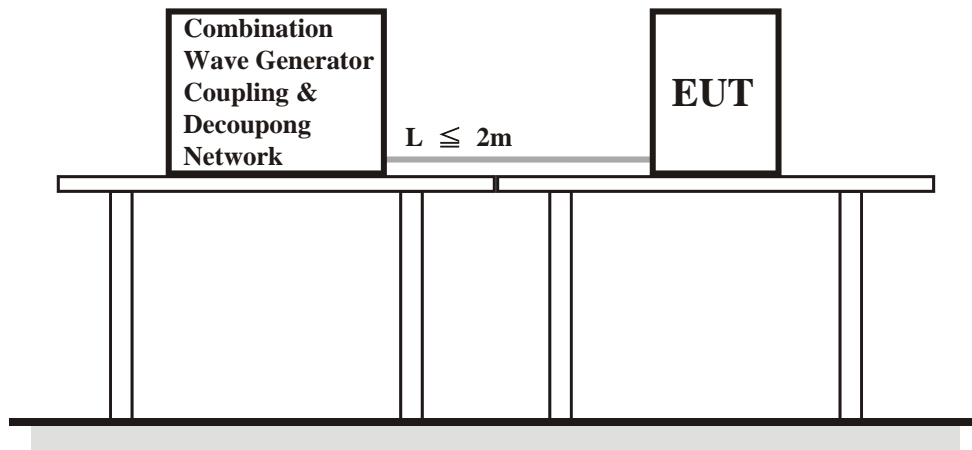

For the actual test configuration, please refer to the related item – Photographs of the Test Configuration.

13.4 Test Results

Input Power	230 Vac, 50 Hz	Tested by	Bernie Lu
Environmental conditions	23 °C, 67% RH	Test Date	2021/4/8
Test mode	Mode 1		

Battery referenced ports (except at the output of energy sources),
Auxiliary a.c. power input ports (rated voltage ≤ 400 Vrms)

Voltage (kV)	Test Point	Polarity (+/-)	Observation	Performance Criterion
0.5, 1	L1-L2	+/-	Note	A
0.5, 1, 2	L1-PE	+/-	Note	A
0.5, 1, 2	L2-PE	+/-	Note	A

Note: The EUT function was correct during the test.

14 Immunity to Conducted Disturbances Induced by RF Fields (CS)

14.1 Test Specification

Basic Standard:	EN 61000-4-6
Frequency Range:	0.15 MHz - 80 MHz
Voltage Level:	Battery referenced ports (except at the output of energy sources), Auxiliary a.c. power input ports (rated voltage \leq 400 Vrms), Signal & communication, process measurement & control ports: 10 V
Modulation:	1kHz Sine Wave, 80%, AM Modulation
Frequency Step:	1 % of preceding frequency value
Dwell Time	3 seconds

14.2 Test Instruments

For AC Power & LAN (Port 1) test

Description & Manufacturer	Model No.	Serial No.	Cal. Date	Cal. Due
ROHDE & SCHWARZ Signal Generator	SML03	101801	Jan. 13, 2021	Jan. 12, 2022
Digital Sweep Function Generator	8120	984801	NA	NA
AR Power Amplifier	75A250AM1	306331	NA	NA
FCC Coupling Decoupling Network	FCC-801-M2-16A	01047	Jun. 18, 2020	Jun. 17, 2021
FISCHER CUSTOM COMMUNICATIONS EM Injection Clamp	F-203I-23mm	455	NA	NA
FISCHER CUSTOM COMMUNICATIONS Current Injection Clamp	F-120-9A	361	Jul. 30, 2020	Jul. 29, 2021
B&K Ear Simulator	4185	2553594	NA	NA
EM TEST Coupling Decoupling Network	CDN M1/32A	306508	Jun. 18, 2020	Jun. 17, 2021
TESEQ Coupling Decoupling Network	CDN T800	34428	Jun. 18, 2020	Jun. 17, 2021
TESEQ Coupling Decoupling Network	CDN T800	29459	Jun. 18, 2020	Jun. 17, 2021
TESEQ Coupling Decoupling Network	CDN T8-230	56641	Feb. 25, 2021	Feb. 24, 2022
TESEQ Coupling Decoupling Network	CDN T8-230	56642	Feb. 25, 2021	Feb. 24, 2022
R&S Power Sensor	NRV-Z5	837878/039	Nov. 10, 2020	Nov. 9, 2021
R&S Power Meter	NRVD	837794/040	Nov. 10, 2020	Nov. 9, 2021
TESEQ Coupling Decoupling Network	CDN M232	37702	Jun. 18, 2020	Jun. 17, 2021
TESEQ Coupling Decoupling Network	CDN M332	41258	Jun. 18, 2020	Jun. 17, 2021
TESEQ Coupling Decoupling Network	CDN M332	41256	Jun. 18, 2020	Jun. 17, 2021
TESEQ Coupling Decoupling Network	CDN T8-10	40376	Jun. 18, 2020	Jun. 17, 2021
TESEQ Coupling Decoupling Network	CDN T8-230	56643	Feb. 25, 2021	Feb. 24, 2022
TESEQ Coupling Decoupling Network	CDN S200	53490	May 26, 2021	May 25, 2022
TESEQ Coupling Decoupling Network	CDN S400	52115	Jun. 18, 2020	Jun. 17, 2021
TESEQ Coupling Decoupling Network	CDN T400A	49918	Feb. 25, 2021	Feb. 24, 2022
FCC Coupling Decoupling Network	FCC-801-M5-50A	100018	Jan. 19, 2021	Jan. 18, 2022
TESEQ Coupling Decoupling Network	CDN T2A-10	54942	Feb. 25, 2021	Feb. 24, 2022
TESEQ Coupling Decoupling Network	CDN S751A	56435	Feb. 25, 2021	Feb. 24, 2022
TESEQ Coupling Decoupling Network	CDN ST08A	56527	Feb. 25, 2021	Feb. 24, 2022
TESEQ Coupling Decoupling Network	CDN ST08A	56525	Feb. 25, 2021	Feb. 24, 2022
TESEQ Coupling Decoupling Network	CDN M432S	56519	Feb. 25, 2021	Feb. 24, 2022
TESEQ Coupling Decoupling Network	CDN S751A	56436	Feb. 25, 2021	Feb. 24, 2022
Software	CS_V7.4.2	NA	NA	NA

- Note:
1. The calibration interval of the above test instruments is 12 months and the calibrations are traceable to NML/ROC and NIST/USA.
 2. The test was performed in CS Room No. 1.
 3. Tested Date: Jun. 15, 2021

For LAN (Port 2) test

Description & Manufacturer	Model No.	Serial No.	Cal. Date	Cal. Due
ROHDE & SCHWARZ Signal Generator	SML03	101801	Jan. 13, 2021	Jan. 12, 2022
Digital Sweep Function Generator	8120	984801	NA	NA
AR Power Amplifier	75A250AM1	306331	NA	NA
FCC Coupling Decoupling Network	FCC-801-M2-16A	01047	Jun. 17, 2021	Jun. 16, 2022
FISCHER CUSTOM COMMUNICATIONS EM Injection Clamp	F-203I-23mm	455	NA	NA
FISCHER CUSTOM COMMUNICATIONS Current Injection Clamp	F-120-9A	361	Jul. 30, 2020	Jul. 29, 2021
B&K Ear Simulator	4185	2553594	NA	NA
EM TEST Coupling Decoupling Network	CDN M1/32A	306508	Jun. 17, 2021	Jun. 16, 2022
TESEQ Coupling Decoupling Network	CDN T800	34428	Jun. 17, 2021	Jun. 16, 2022
TESEQ Coupling Decoupling Network	CDN T800	29459	Jun. 17, 2021	Jun. 16, 2022
TESEQ Coupling Decoupling Network	CDN T8-230	56641	Feb. 25, 2021	Feb. 24, 2022
TESEQ Coupling Decoupling Network	CDN T8-230	56642	Feb. 25, 2021	Feb. 24, 2022
R&S Power Sensor	NRV-Z5	837878/039	Nov. 10, 2020	Nov. 9, 2021
R&S Power Meter	NRVD	837794/040	Nov. 10, 2020	Nov. 9, 2021
TESEQ Coupling Decoupling Network	CDN M232	37702	Jun. 17, 2021	Jun. 16, 2022
TESEQ Coupling Decoupling Network	CDN M332	41258	Jun. 17, 2021	Jun. 16, 2022
TESEQ Coupling Decoupling Network	CDN M332	41256	Jun. 17, 2021	Jun. 16, 2022
TESEQ Coupling Decoupling Network	CDN T8-10	40376	Jun. 17, 2021	Jun. 16, 2022
TESEQ Coupling Decoupling Network	CDN T8-230	56643	Feb. 25, 2021	Feb. 24, 2022
TESEQ Coupling Decoupling Network	CDN S200	53490	May 26, 2021	May 25, 2022
TESEQ Coupling Decoupling Network	CDN S400	52115	Jun. 17, 2021	Jun. 16, 2022
TESEQ Coupling Decoupling Network	CDN T400A	49918	Feb. 25, 2021	Feb. 24, 2022
FCC Coupling Decoupling Network	FCC-801-M5-50A	100018	Jan. 19, 2021	Jan. 18, 2022
TESEQ Coupling Decoupling Network	CDN T2A-10	54942	Feb. 25, 2021	Feb. 24, 2022
TESEQ Coupling Decoupling Network	CDN S751A	56435	Feb. 25, 2021	Feb. 24, 2022
TESEQ Coupling Decoupling Network	CDN ST08A	56527	Feb. 25, 2021	Feb. 24, 2022
TESEQ Coupling Decoupling Network	CDN ST08A	56525	Feb. 25, 2021	Feb. 24, 2022
TESEQ Coupling Decoupling Network	CDN M432S	56519	Feb. 25, 2021	Feb. 24, 2022
TESEQ Coupling Decoupling Network	CDN S751A	56436	Feb. 25, 2021	Feb. 24, 2022
Software	CS_V7.4.2	NA	NA	NA

- Note:
1. The calibration interval of the above test instruments is 12 months and the calibrations are traceable to NML/ROC and NIST/USA.
 2. The test was performed in CS Room No. 1.
 3. Tested Date: Jul. 7, 2021

14.3 Test Arrangement

- The EUT shall be tested within its intended operating and climatic conditions.
- An artificial hand was placed on the hand-held accessory and connected to the ground reference plane.
- One of the CDNs not used for injection was terminated with 50 ohm, providing only one return path. All other CDNs were coupled as decoupling networks.
- The frequency range is swept from 150 kHz to 80 MHz, using the signal level established during the setting process and with a disturbance signal of 80 % amplitude. The signal is modulated with a 1 kHz sine wave, pausing to adjust the RF signal level or the switch coupling devices as necessary. Where the frequency is swept incrementally, the step size shall not exceed 1 % of the preceding frequency value.
- Attempts should be made to fully exercise the EUT during testing, and to fully interrogate all exercise modes selected for susceptibility.

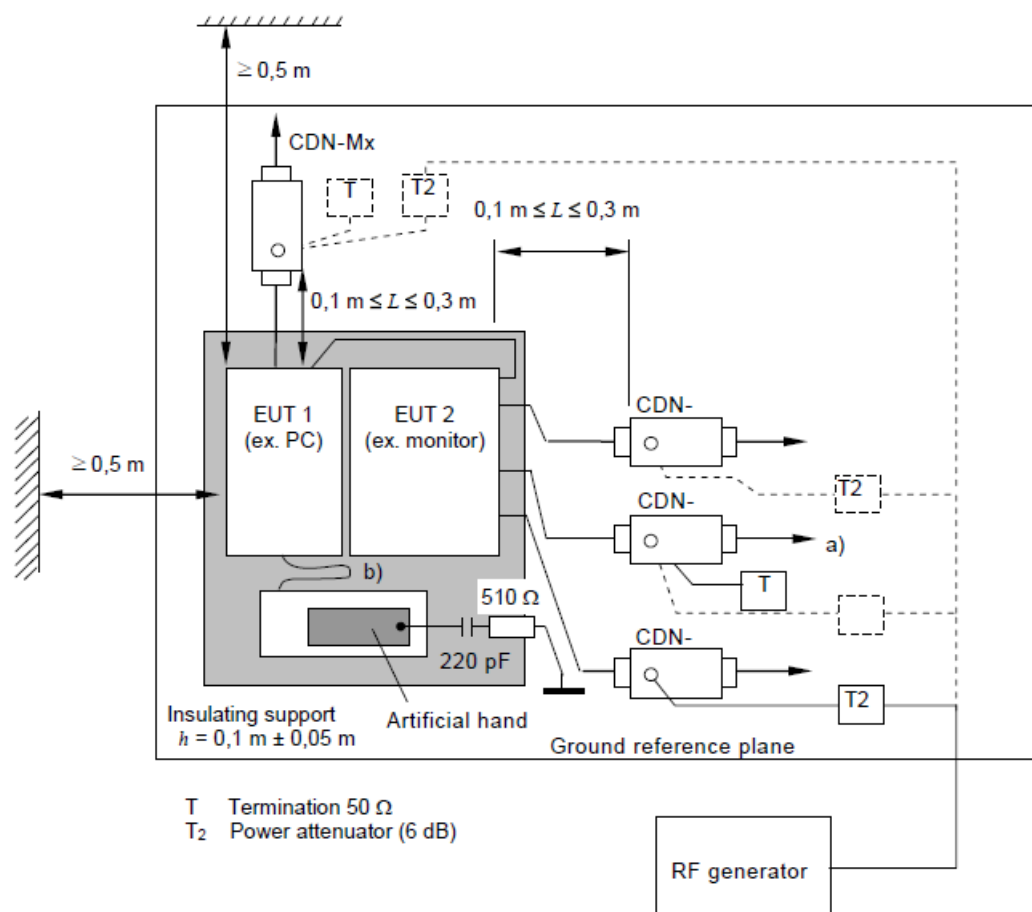

- Note:**
- The EUT clearance from any metallic obstacles shall be at least 0,5 m.
 - Interconnecting cables (≤ 1 m) belonging to the EUT shall remain on the insulating support.
 - The equipment to be tested is placed on an insulating support of 0.1 meters height above a ground reference plane. All relevant cables shall be provided with the appropriate coupling and decoupling devices at a distance between 0.1 meters and 0.3 meters from the projected geometry of the EUT on the ground reference plane.

For the actual test configuration, please refer to the related item – Photographs of the Test Configuration.

14.4 Test Results

Input Power	230 Vac, 50 Hz	Tested by	Xun Lee
Environmental conditions	23 °C, 68% RH	Test Date	2021/6/15
Test mode	Mode 1		

Frequency (MHz)	Level (V rms)	Tested Line	Injection Method	Return Path	Observation	Remark	Performance Criterion
0.15 – 80	10	AC Power	CDN-M3	CDN-M1	Note	-	A
0.15 – 80	10	LAN (Port 1)	CDN-ST08A	CDN-M1	Note	-	A

Note: The EUT function was correct during the test.

Input Power	230 Vac, 50 Hz	Tested by	Kent Wang
Environmental conditions	26 °C, 74% RH	Test Date	2021/7/7
Test mode	Mode 1		

Frequency (MHz)	Level (V rms)	Tested Line	Injection Method	Return Path	Observation	Remark	Performance Criterion
0.15 – 80	10	LAN (Port 2) ^{Remark 1}	CDN-ST08A	CDN-M1	Note	-	A
0.15 – 80	10	LAN (Port 2) ^{Remark 2}	CDN-ST08A	CDN-M1	Note	-	B

Note: 1. The EUT function was correct during the test.

2. The EUT ping LAN time out and disconnect during the test frequency at 51MHz -80MHz, but auto recovered after the test.

Remark:

1. As client's request, during the test the EUT LAN (Port 2) test speed: 1Gbps.

2. During the test the EUT LAN (Port 2) test speed: 2.5Gbps.

15 Pictures of Test Arrangements

15.1 Conducted Disturbance at Auxiliary a.c. or d.c. power ports

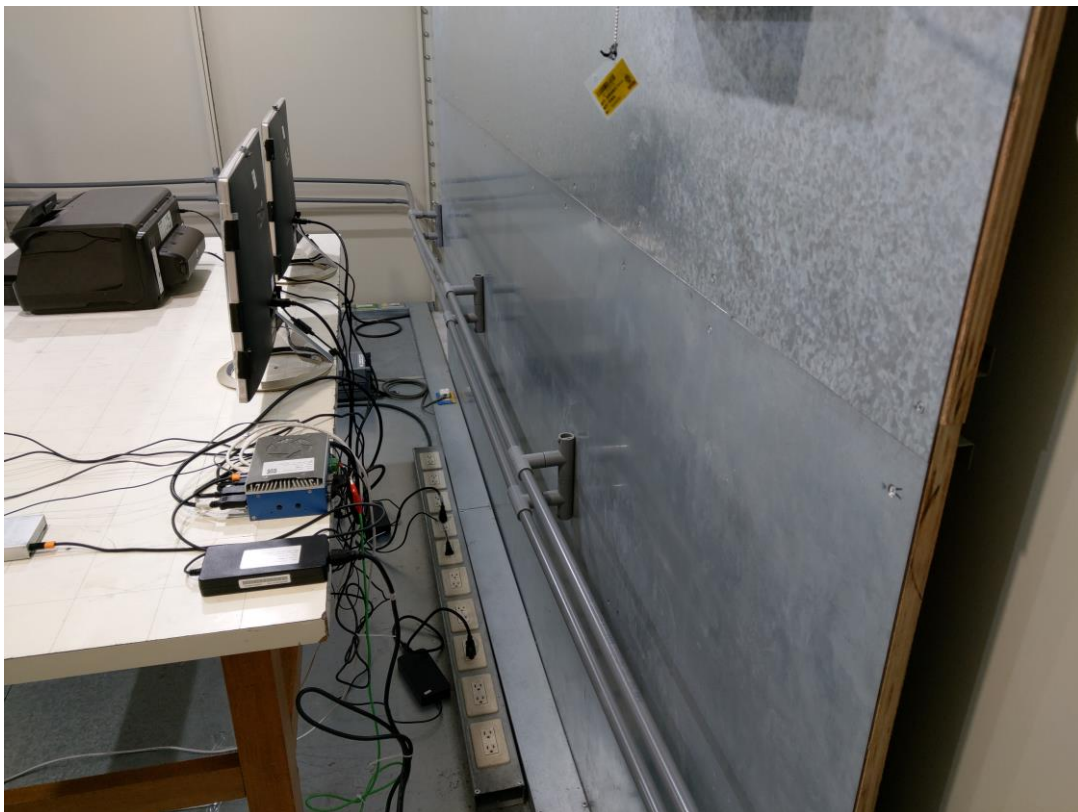

15.2 Radiated Disturbance up to 1 GHz



15.3 Radiated Disturbance above 1 GHz

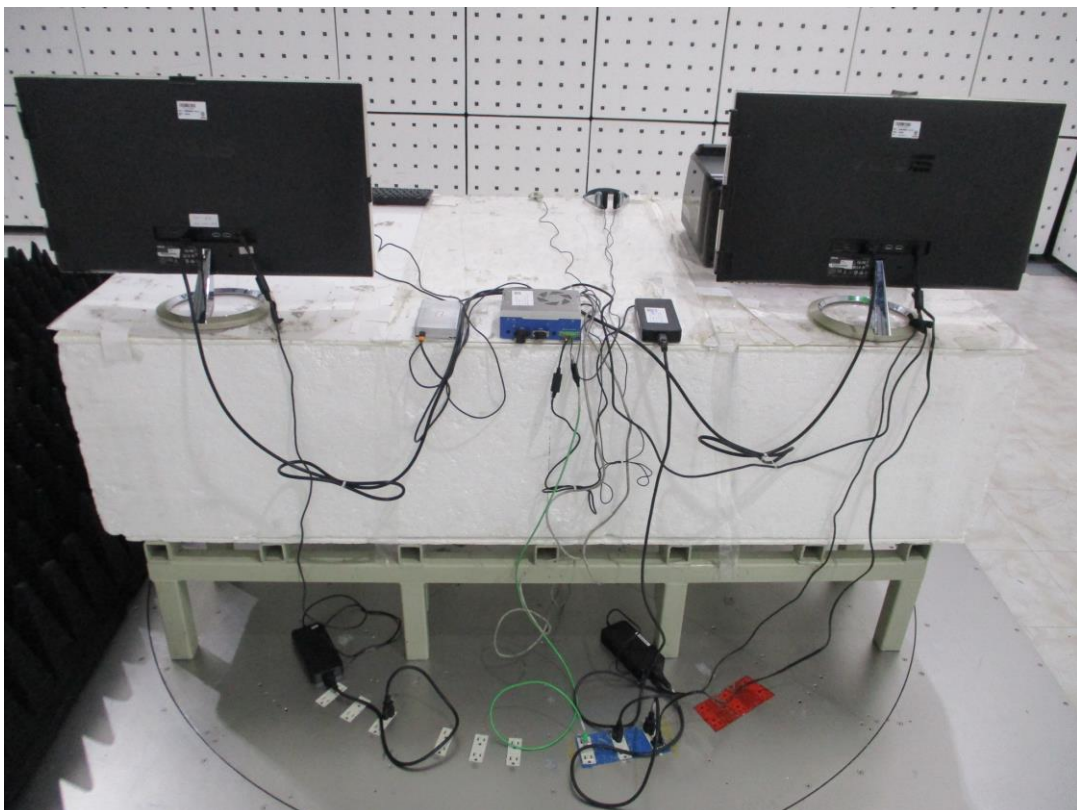

15.4 Harmonics Current, Voltage Fluctuations and Flicker Measurement

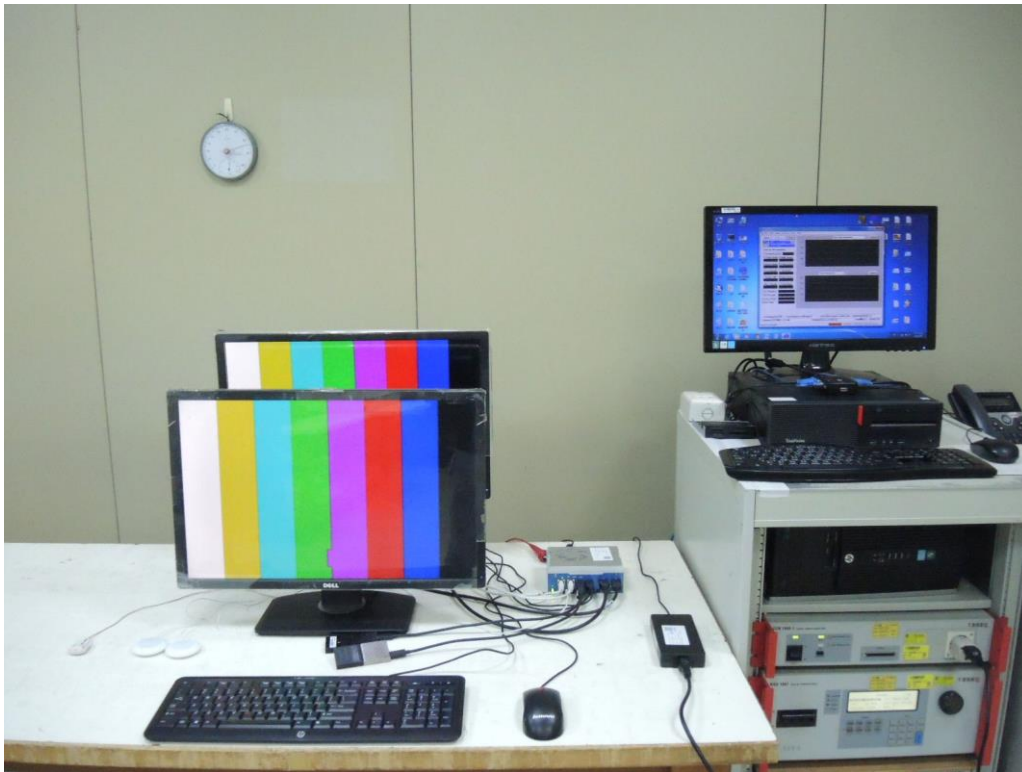

15.5 Electrostatic Discharge Immunity Test (ESD)

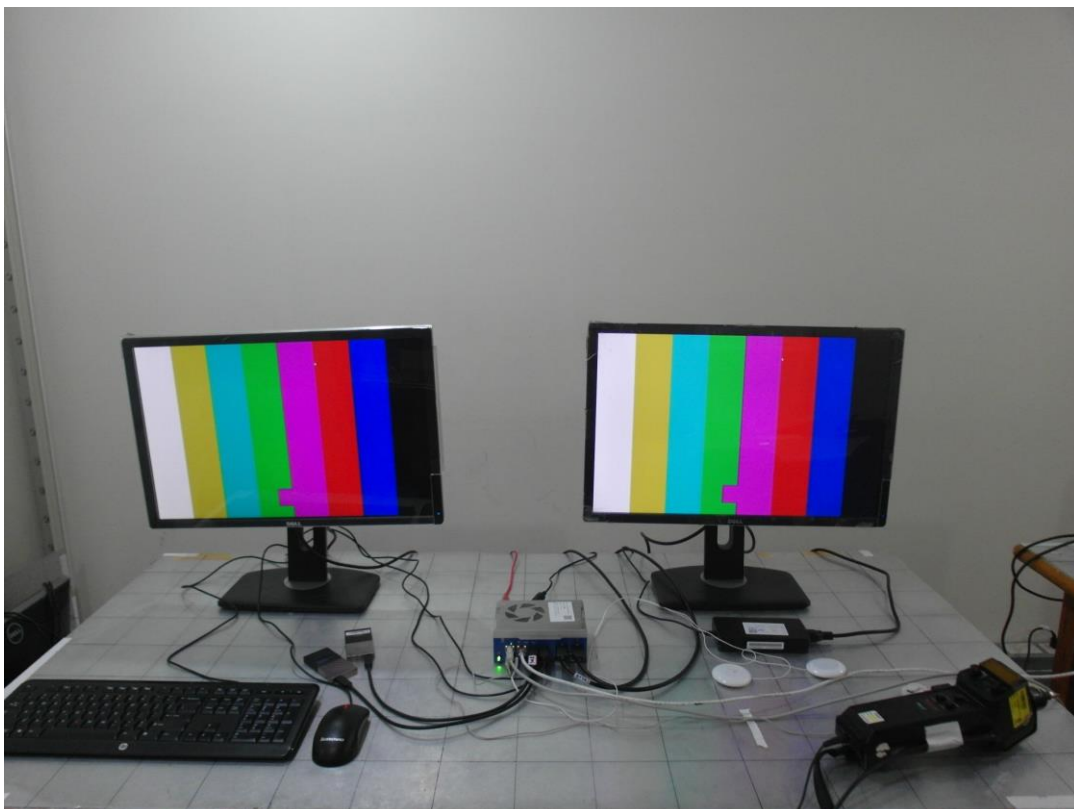

15.6 Radio-frequency Electromagnetic Field Immunity Test (RS)

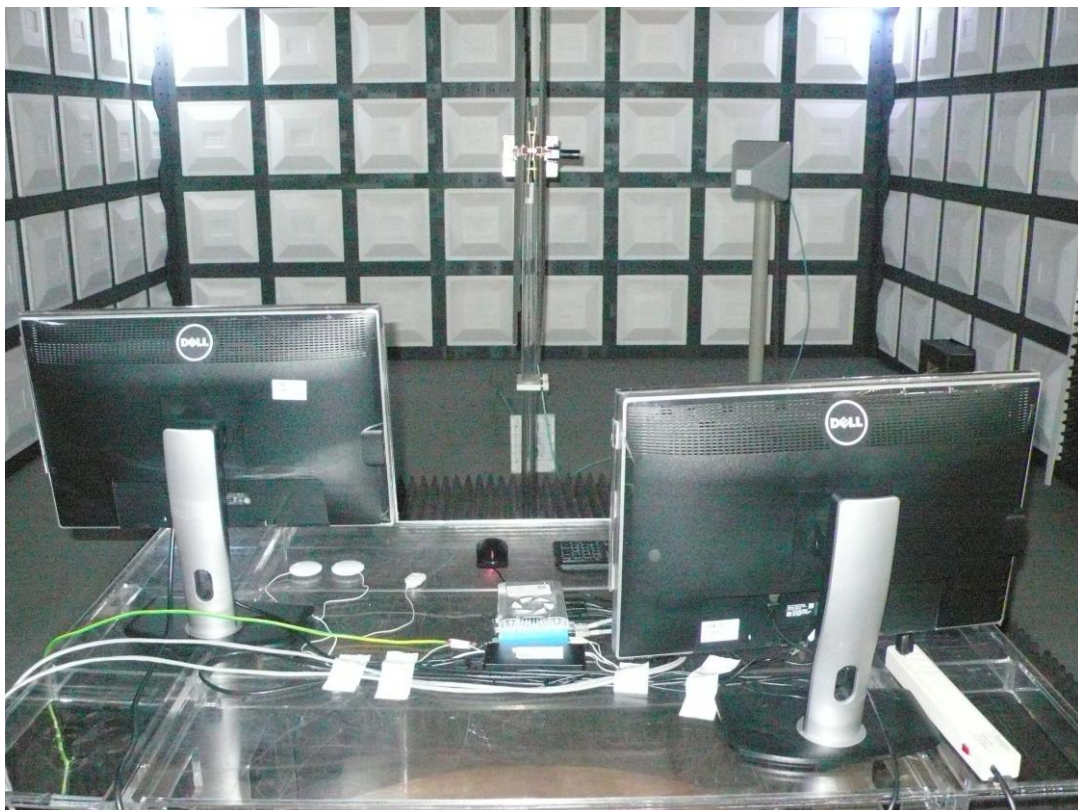

15.7 Fast Transients (EFT)

Mains port



LAN 1



LAN 2

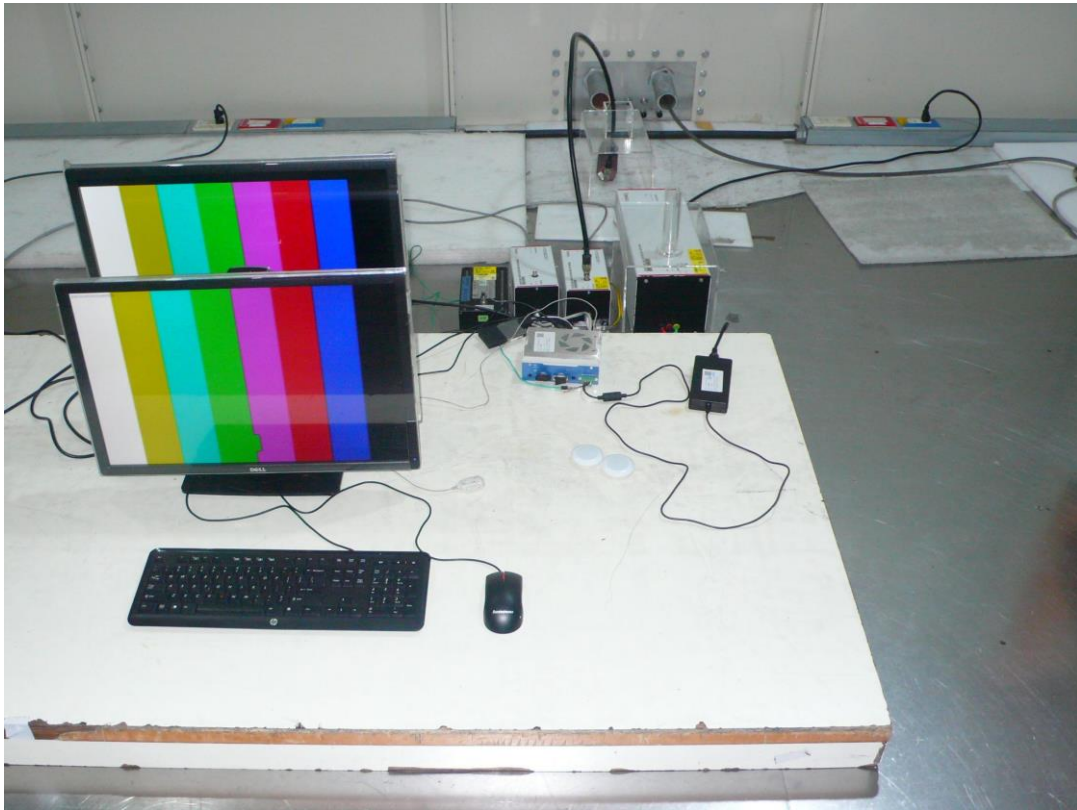

15.8 Surge

Mains ports



15.9 Radio-frequency common mode (CS)

Mains port



LAN 1

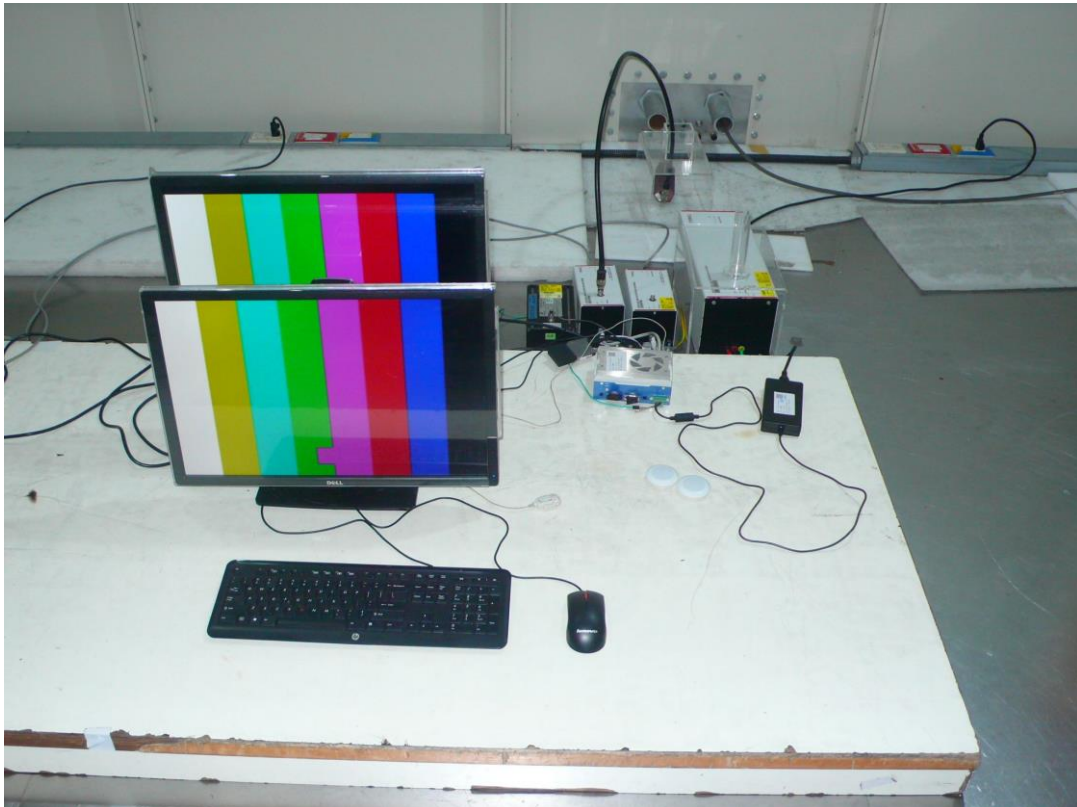

LAN 2

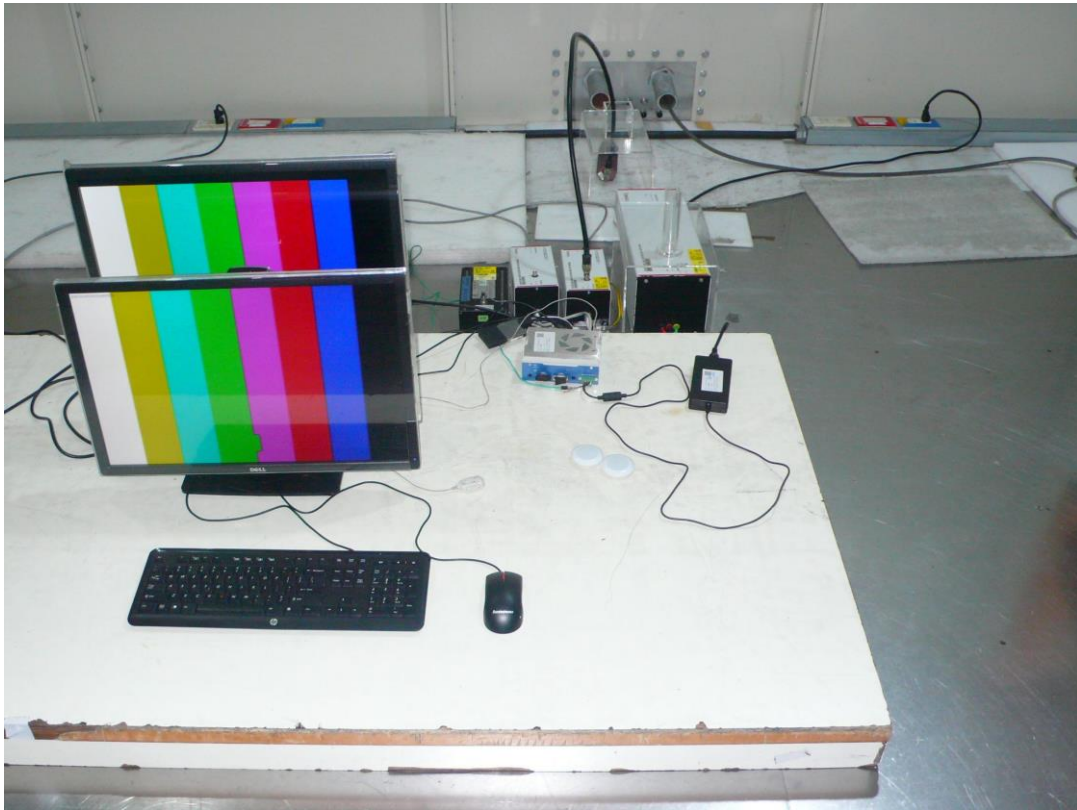

Appendix – Information of the Testing Laboratories

We, Bureau Veritas Consumer Products Services (H.K.) Ltd., Taoyuan Branch, were founded in 1988 to provide our best service in EMC, Radio, Telecom and Safety consultation. Our laboratories are accredited and approved according to ISO/IEC 17025.

If you have any comments, please feel free to contact us at the following:

Lin Kou EMC/RF Lab

Tel: 886-2-26052180

Fax: 886-2-26051924

Hsin Chu EMC/RF/Telecom Lab

Tel: 886-3-6668565

Fax: 886-3-6668323

Hwa Ya EMC/RF/Safety Lab

Tel: 886-3-3183232

Fax: 886-3-3270892

Email: service.adt@tw.bureauveritas.com

Web Site: www.bureauveritas-adt.com

The address and road map of all our labs can be found in our web site also.

--- END ---